



Horseshoe Pitching NEWSLINE

Official Publication of the National Horseshoe Pitchers Association
VOL. 15, NO. 2

MARCH/APRIL 2003

Horseshoe Pitching A Sport for All Ages

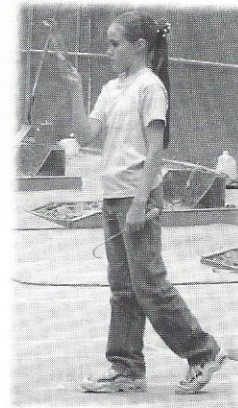
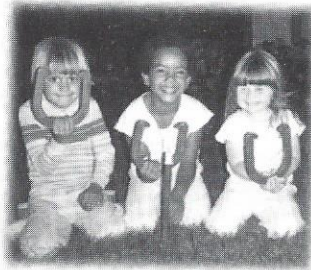

Now in 11 models!
 All shoes are NHPA Sanctioned.
 One year warranty
 Pairs are match weighted to within
 1/5 of an ounce!
 All models are dead soft
 We've got a shoe for every style!



Made
 In The
 USA

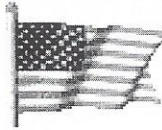

ADD HORSEPOWER TO
 YOUR GAME!

PITCH THOROUGHBRED
 PITCHING SHOES

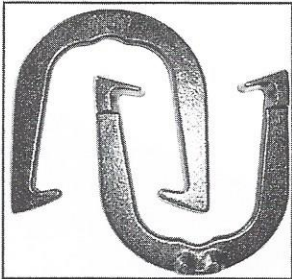

GLORY

\$34 per pair, 2 for \$59!!
 Stock #33-051

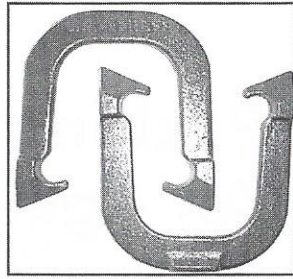

CHALLENGER

\$39 per pair, 2 FOR \$69!!
 Stock #33-243

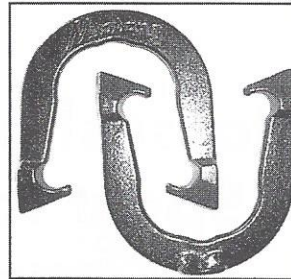

MUSTANG

\$48 per pair
 Stock #33-033

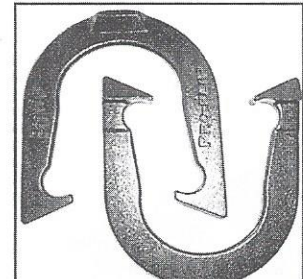

BRONCO PRO-FLIP

\$48 per pair
 Stock #33-123

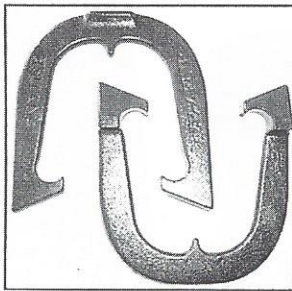

SNYDER E-Z FLIP

\$54 per pair
 Stock #33-596

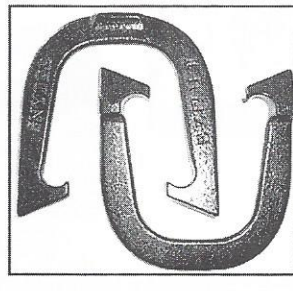

SNYDER E-Z FLIP II

\$54 per pair
 Stock #33-535

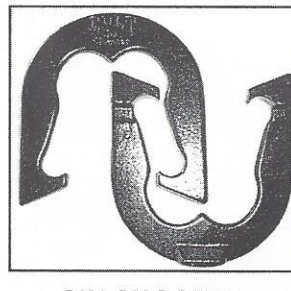

SIX SHOOTER

\$54 per pair
 Stock #33-045

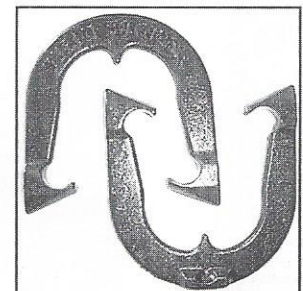

TYSON SWINGER

\$54 per pair
 Stock #33-747

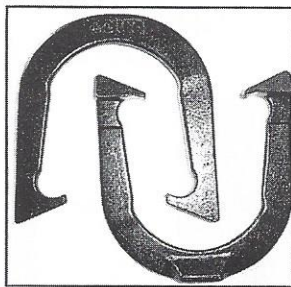

PONY (Light-weight Shoe)

\$45 per pair
 Stock #33-010

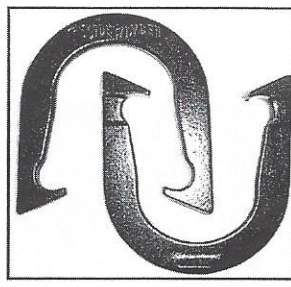

SIDEWINDER

\$45 per pair
 Stock #33-969

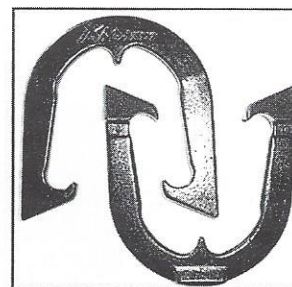

MAGNET

\$45 per pair
 Stock #33-007

View all our stuff and order on-line at: www.horseshoesonline.com

Accepting major credit cards

Toll free order line:
 1-800-841-4685



**WHITE
 DISTRIBUTORS**
 P.O. BOX 3652
 ERIE, PA 16508

All above models are available through any NHPA Distributor

PA residents must add 6% sales tax when ordering direct from us. Above prices do not include S & H fees— S & H for 1 pair is \$7.35, 2 pair is \$9.60, 3 pair is \$12.00. Price breaks on all models when ordering 3 or more pair of any combination.

We carry most top brands of horseshoes and accessories, plus, custom shirts and caps.
 Call anytime for a free catalog!



Horseshoe Pitching NEWSLINE

Official Publication of the National Horseshoe Pitchers Association

CONTENTS

President's Message <i>by Dave Loucks</i>	4
Dave's Court Report <i>by Dave Loucks</i>	4, 5
Cartoon <i>by Robert E. Taylor</i>	5
NHPF News & Contribution Update <i>by Dave Loucks</i>	6
NHPA Income and Expenditures	7
Mailbag	7
Paul Stewart For Fifth Vice-President	7
Sanctioned Club/League Report <i>by Lorraine Sternberg</i>	8
Newsline Renewal Form	8
Publicity Promotion <i>by Casey Sluys</i>	9, 10
Hall of Fame <i>by Earl and Vicki Winston</i>	11
Lorraine Sternberg for Third Vice President	11
World Tournament Information	12-14
World Tournament Prize List for Year 2003	15
Junior Promotions <i>by Heidi Poppe</i>	15, 16
Insurance <i>by Bonnie Seibold</i>	16
Upcoming Events	17
The Horseshoe Trader <i>by Bob Dunn</i>	18
Regional Director's Report <i>by Allen Baptist</i>	19
Horseshoe Pitching On Television <i>by Coyce Allen</i>	20
Director of the Year 2002	20
NHPA Online <i>by Paul Stewart</i>	22
Sanctioned League 2002 Top Ten List	24-26
Lifetime Records of Carl Steinfeldt <i>by Bart Sargent</i>	27
U.P. Sports Hall of Fame	28
Maryland State Championships Correction	28
The Toll of Time	29
Valley of the Sun Results	29
Tournament Contacts	30

PAID ADVERTISEMENTS

White Distributors	Inside Front Cover
Imperial	5
Six Pac	9, 11
Elmer Hohl	16
Mr. D's	19
Ted Allen	20
Summerfun Tournament	21
Gordon	22
Danville Illinois 15 th Annual Open	23
Deadeye	25
Bill Vanderburg Horseshoe Company	27
St. Pierre Manufacturing	Outside Back Cover

NHPA NATIONAL OFFICERS

PRESIDENT: DAVE LOUCKS, 6233 Woodman Dr., Lake Oroville, CA 95966 (530) 589-9818, email: NHPAdave@cncnet.com

1ST VICE PRESIDENT: ALLEN BAPTIST, P.O. Box 867, Eagle, CO 81631 (970) 328-1626, email: beckybaptist@msn.com

2ND VICE PRESIDENT: CASEY SLUYS, 1721 San Ramon Way, Santa Rosa, CA 95409 (707) 538-3128, email: kcslus@worldnet.att.net

3RD VICE PRESIDENT: LORRAINE STERNBERG, W206 N13520 Woodside Ln., Richfield, WI 53076 (262) 677-3300
email: horshoewi@aol.com

4TH VICE PRESIDENT: BONNIE SEIBOLD, 1043 Grayston Ave., Huntington, IN 46750 (260) 356-3489, email: wseibold@fwi.com

5TH VICE PRESIDENT: PAUL STEWART, 1043 Old Mountain Rd., Statesville, NC 28677 (704) 528-5081
email: nhpa5vp@bellsouth.net

SECRETARY/TREASURER: DICK HANSEN, 3085 76th St., Franksville, WI 53126 (262) 835-9108
email: nhpa.sec.treas@worldnet.att.net

PROGRAM & COMMITTEE DIRECTORS

GAME RELATED SALES: ED DOMEY, P.O. Box 298, Sutton, MA 01590 (508) 865-9477

JUNIOR PROMOTION: HEIDI POPPE, 1801 Lillian Dr., Hudson, WI 54016 (715) 381-3628 email: hrpoppe@spacestar.net

PUBLICITY/PROMOTION: 2nd VP, CASEY SLUYS

HISTORIAN: GARY KLINE, 605 Brantly Ave., Dayton, OH 45404

NATSTATS: GLENN JAMIESON, 3231 Vineyard Ave., #17, Pleasanton, CA 94566-6359 (925) 462-6030
email: natstatguy@aol.com

HALL OF FAME: EARL & VICKI WINSTON, 10326 Highway D, LaMonte, MO 65337, email: secMOHPA@iland.net

REGIONAL DIRECTORS: 1st VP, ALLEN BAPTIST

SANCTIONED CLUB/LEAGUE: 3rd VP, LORRAINE STERNBERG

RULES AND BYLAWS: 4th VP, BONNIE SEIBOLD

GRIEVANCE & INSURANCE: 4th VP, BONNIE SEIBOLD

WEBSITE: 5th VP, PAUL STEWART

WEBMASTER: STEVE SUMMERLIN, P.O. Box 536, Webberville, MI 48892-0536

NHPA NEWSLINE

PUBLISHER / EDITOR: PAULA SUMMERLIN

DESIGN/PRODUCTION: ASAP PRINTING, Okemos, MI

PUBLISHER'S POLICY: NHPA *Newsline* is the official magazine of the National Horseshoe Pitchers Association. The contents may not be reproduced in any manner without prior permission of the Editor. Six issues are published annually on a bi-monthly basis. Back issues or additional copies of *Newsline*, subject to availability, are \$3.00 each postage included, \$5.00 for World Tournament issue.

ADVERTISING POLICY: The publisher reserves the right to refuse any ad. All ads accepted must be paid for in advance and meet specific format requirements. The publication of any ad is not necessarily an endorsement of the advertiser nor the featured product or service. Rate inquiries, ad copy and fee should be sent to NHPA *Newsline*, Paula Summerlin, P.O. Box 536, Webberville, MI 48892-0536

LETTERS POLICY: *Newsline* welcomes communication and articles from the membership. Submissions should be provided on disk or e-mail in text format (MS Word preferable) or typed, double spaced and should include the writer's name, address and phone number. The editor reserves the right to accept or reject any letter or advertising material. All submissions are subject to editing, available space, and must be received by the first day of the month preceding the date of issue. Email address: psummerlin@cablespeed.com
NHPA *Newsline*, Paula Summerlin, P.O. Box 536, Webberville, MI 48892-0536 Phone: (517) 521-1262

SUBSCRIPTION POLICY: The annual subscription price is \$12.00 in the United States which includes postage via discounted standard mail. Add \$8.00/yr. for First Class Mail. Canadian subscriptions are \$20.00 U.S. funds. All new subscriptions, renewals, payment and changes of address must be sent directly to:
NHPA, 3085 76th Street, Franksville, WI 53126
Phone/Fax (262) 835-9108

PRESIDENT'S MESSAGE *by Dave Loucks*

The 2002 year-end membership report by secretary, Dick Hansen, came with some welcome news. For the first year in many, adult membership stopped declining. In fact, at 12,566, it was up slightly over 2001 but so slight that we can say it has stayed level for the last two years. Hopefully, we have seen an end to a ten-year slide that saw membership declining at an average of about 200 per year from a high of 14,844 in 1991. Maintaining a steady or growing membership is a goal of any organization but it is not easy as Promotion Director Casey Sluys pointed out in his last Newslines article. It takes a devoted and serious effort at the club and league level to attract new members or to bring back pitchers who have dropped aside. The NHPA Executive Council realizes that those efforts may incur some cost in addition to time. Therefore, at our recent winter meeting, we discussed and approved a trial program that will financially assist those charters that make a concerned effort to attract new members.

The NHPA is starting a co-op advertising program that can reimburse charters up to 75% of their out of pocket

cost for ads and promotion efforts aimed solely at bringing in new members. There are limitations and guidelines of course and these will be better defined in later issues of this magazine and on the NHPA website. Basically, the NHPA will reimburse 75% of the cost of an Ad up to a maximum of \$2.00 per the charter's previous year-end adult membership. The charter can advertise in Newspaper, magazine, radio, TV, classified and yellow pages. The thrust of the promotion must be an attempt to attract new members to the charter. Individual clubs could do this but they must coordinate with the charter so two or more clubs don't vie for the same money. Upon presentation to and approval by the NHPA 2nd VP of ad tear sheets, radio or TV announcement proofs, along with the total bill that has been prepaid, the NHPA will reimburse 75% of the cost up to the \$2.00 per member maximum. This is a trial program for at least this year. We will evaluate its effectiveness by reports from the 2nd Vice-President and the 2003 ending membership report.

DAVE'S COURT REPORT *by Dave Loucks*

Eau Claire W.T.

The entry form and prize list for this year's World can be found in this issue. We will have only 48 courts indoors and with an expected large turnout that could mean 5 pitching shifts a day. The Championship Men and Women groups have been enlarged to 24 pitchers with the 16 high entering percentages getting a direct seed to the championship. The remaining 8 spots will be filled by the best percentages from class play. Other championship divisions will remain the same size as last year though we will seed directly to the championship, the top 8 entering averages in both the Elders and Senior Men Divisions. Senior Women, which had their own five classes last year, may be seeded back among the open women if their entry level does not increase.

National Sanctioned League Team Tournament Approved

The Executive Council discussed a member proposed National Tournament for Sanctioned League Clubs to be held in Joelton on weekends running from the 2nd weekend in November through the end of January. While the idea was supported, the time frame was considered too long and scheduling cumbersome due to three holiday weekends and four Tennessee tournaments scheduled for the courts. Thus, we approved a Sanctioned League Team

Tournament to be held over two consecutive weekends in November, the 15th/16th and 22nd/23rd. The event will be limited to a maximum of 48 three-person teams with no more than 24 playing each weekend. It will be a handicap event in which your players will compete against all three members of five other teams (assuming groups of six) over one weekend. The event will be somewhat similar to the Music City Team Tournament in format except that handicap and count-all scoring will be used. Further details will come later from 3rd VP Lorraine Sternberg who will be one of the coordinators of this event.

Projecting Championship Standings

For years, the NHPA had used several large pegboards with names & win-loss records for the Division Championship Finals at world tournaments. These leader boards were cumbersome, difficult to transport and set-up and a pain to use. In Red Deer, we decided to rent a special projector to display on the wall; blown-up game-by-game standings that were computer generated after the scores were turned in. The concept proved to be much easier to handle and extremely favorable with the players and spectators. As such, we will continue the process this and future years using a new laptop and projector the NHPA Council approved to purchase for the purpose.

One Man's Special Contribution

The NHPF indeed appreciates all the contributions received from members. But once in a while we receive something special, something out of the ordinary that really comes from the heart. Such a gift and letter came to me about Christmas time. I'd like to share with you that short letter.

"Dear Dave,
2002 has been one of those special years on the courts. A perfect game, a 3-peat at the Flemington Open, a record performance as NJ State Elder Champ and induction into the New Jersey Hall of Fame.

I can't give any of the above to the NHPF but I can donate my 2002 tournament winnings, \$730.00. Enclosed is a check in that amount.

Wishoe The Best,
Quig"

For those of you who might not recognize the sender, let me introduce you to Edward Quigley, NHPA Regional Director for New Jersey and the 2nd Vice President of the NJSHPA. Ed, the NHPA and NHPF sincerely appreciate your continued work and support of organized horseshoe pitching. We hope that 2003 brings you an equal amount of success and that some of your work ethic and generosity brushes off onto others.

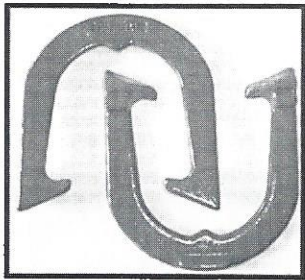
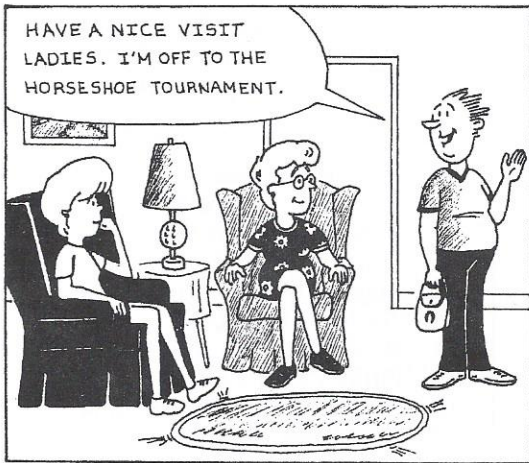

ORIGINAL
(Drop-forged Steel)

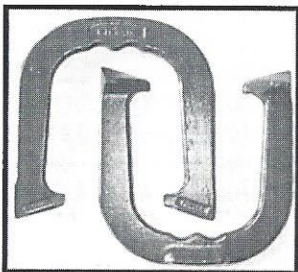

CLASSIC
(Drop-forged Steel)

YOUR CHOICE



\$52.00 PER PAIR
(Plus S & H)

IMPERIAL HORSESHOES

Highest quality shoes made today.

All three drop-forged shoes are made from super dead soft steel and have hardened tips.

The cast shoe is made of soft ductile iron.

New ownership, see below

Send orders to:
White Distributors
P.O. Box 3652
Erie, PA 16508

Order Anytime:
1-800-841-4685

See our inside front cover ad for details on S & H fees.

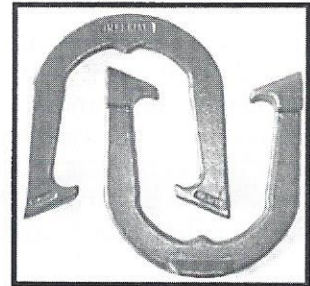

PLUS
(Drop-forged Steel)

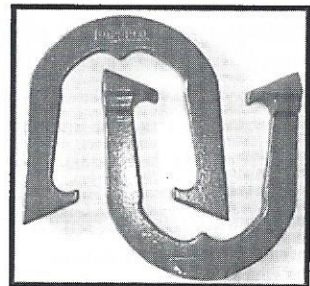

MAXX
(Cast Ductile Iron)

Order direct or from any NHPA Distributor. Check us out on-line at: www.horseshoesonline.com

NHPF NEWS & CONTRIBUTION UPDATE *by Dave Loucks*

Many thanks to the members who opened up their hearts and wallets to the NHPF during the Holiday Season. Close to thirty members sent in contributions between Thanksgiving and New Year's. Among them were gifts exceeding \$400 from the Colorado HPA, Laymon Gullett, G.H. Harris, Casey & Gail Sluys and Ed Quigley. Those, along with the NHPA donation of \$1.00 per member gave the NHPF a nice starting deposit of \$15,867 for the year 2003.

While just under \$3,500 of this came from individual members, it would be wonderful if this amount from the members continued for each month. Annually, it would be a big improvement over what we have been receiving. A recent NHPA membership survey indicated that the average member is not very likely to be well informed about the NHPF. That fact is disappointing but not surprising. Two years ago the NHPF did a mailing to all NHPA households. Included was a professionally done 4-color information pamphlet about the NHPF. In every issue, this special column devoted to the NHPF appears in Newsline. Beyond that, several charter newsletters say something about the NHPF in their issues. Unfortunately, less than 30% of NHPA households subscribe to Newsline and nearly every charter has an annual membership turnover of 10-15%. That means a high percentage of our current membership is probably not well informed about the NHPF. Some may never have heard about it.

Somewhere in the not too distant future, the NHPF will most likely do another mass mailing. The first mailing cost over \$6,500 for printing and postage, so that can be considered a significant amount for a charity that has averaged just \$27,500 in direct member contributions over the last 5 years. Fortunately, the NHPA treasury makes some membership approved donations. There is also some monthly account interest and annual court fees in Joelton. Altogether, total NHPF income has averaged \$41,113 for the past 5 years. That's only about half of the projected annual operating expense expected when Dr. Freeman turns over indoor courts and land later this year.

When that happens, the NHPF will have to take full operation and financial responsibility for land and improvements appraised at nearly \$1,000,000.

If you have not donated before, please consider sending a contribution to the NHPF now. You'll be helping a wonderful cause for the sport you love and your gift is tax-deductible. If you've already donated, please don't stop but pledge to send semi-annual or monthly contributions. Your support is needed and appreciated. A letter will acknowledge any contribution of \$10.00 or more. Your tax-deductible contribution to the "NHPF" can be mailed to either 6233 Woodman Dr., Oroville, CA 95966 or PO Box 159027, Nashville, TN 37215.

Donating \$10-45

David Garen, FL
Barry & Barb Chapelle, OR
Art Moran, MN
Lee McCumsey, IL
Norman Ward, MO
Harry Nelson, WI
Robert Power, IL
Douglas Carr, TN
Robert Cox, MD
Jim Newland, MN
Robert McCullough, CT
Randy Joines, NC
Don & Mary All Ell, MO
Ted Bostwick, WA

Donating \$50-80

Michigan HPA
Bill Henn, KY
Combined Locks H.C., WI
Richard Timmer, IL
Tim Woodden, OR
Glenn King, OK

Donating \$100-150

Jim & Phyllis Quist, WA
Jean Robinson, CA
Billy Joe Hall, LA
Kevin Cone, IA
Roy Hamilton, SC
Pat Moore, CA

Donating \$400+

Colorado HPA
Laymon Gullett, TX

Donating \$500+

G.H. Harris, PA
Casey & Gail Sluys, CA
Edward Quigley, NJ

NHPA MMA Interest \$631

NHPA \$1.00 per 2002 adult member, \$12,566

Total contributions

deposited this reporting period, \$17,062

Total NHPA deposits to date, \$225,865.93

How your state ranks

in number and dollars contributed

1. Tennessee, 45 for \$19,937
2. California, 147 for \$14,409
3. Minnesota, 150 for \$8,629
4. North Carolina, 77 for \$7,483
5. Oregon, 53 for \$7,260
6. Missouri, 70 for \$6,357
7. Georgia, 17 for \$6,140
8. Michigan, 81 for \$6,055
9. Wisconsin, 76 for \$5,578
10. Colorado, 46 for \$5,048
11. Florida, 56 for \$4,388
12. Massachusetts, 9 for \$4,135
13. Texas, 32 for \$3,585
14. Washington, 43 for \$3,486
15. Ohio, 72 for \$3,411
16. Pennsylvania, 41 for \$2,884
17. New Jersey, 29 for \$2,609
18. Illinois, 55 for \$2,465
19. Iowa, 27 for \$2,456
20. Kentucky, 31 for \$2,305
21. Kansas, 26 for \$2,152
22. Nebraska, 22 for \$1,968
23. New York, 31 for \$1,781
24. Indiana, 21 for \$1,603
25. Louisiana, 11 for \$1,217
26. Nevada, 10 for \$1,015
27. Maryland, 26 for \$1,015
28. North Dakota, 7 for \$920
29. South Carolina, 15 for \$870
30. Connecticut, 19 for \$772
31. Montana, 7 for \$520
32. South Dakota, 13 for \$472
33. Oklahoma, 12 for \$458
34. Idaho, 10 for \$445
35. Alabama, 3 for \$370
36. Virginia, 12 for \$368
37. West Virginia, 11 for \$320
38. Arizona, 7 for \$264
39. New Mexico, 4 for \$235
40. Arkansas, 5 for \$185
41. Wyoming, 3 for \$182
42. Hawaii, 3 for \$150
43. Utah, 4 for \$130
44. Alaska, 1 for \$120
45. New Hampshire, 2 for \$105
46. Vermont, 3 for \$75
47. Maine, 1 for \$25
48. Delaware, 1 for \$7
49. Mississippi, 1 for \$5

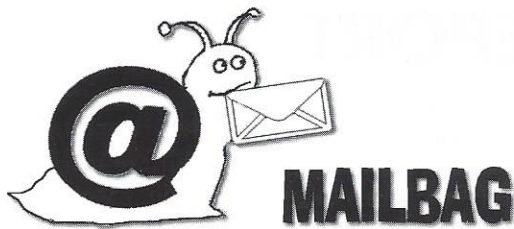

Hello to all,

I just wanted to share an idea that was brought up at our club summit meetings of the past few years. Now is the perfect time to act on this idea.

I am working with Jackie Hughes, MGSHPA Junior Promotions Director, on a project to hold a Horseshoe class for community education in North Branch. It will be a structured class, designed in 2 phases, horseshoe 1 and horseshoe 2. This particular class is aimed at junior pitchers in the area. If all the details can be worked out, the class will start this spring in May. Great work Jackie !!!

Last night I happen to get in the US Mail a brochure for the community education activities in the Rockford area. It was the winter/spring catalog and had a wide variety of activities and sports. In there was a phone number to call if you had any ideas for classes. This is a golden opportunity for a club to hold a 1 or 2 night class on basic horseshoe pitching, open to juniors and adults alike, just prior to the start of their league in the spring. Then you could snag them right into the league from the class. I can assist you with class materials and maybe handouts. What a great way to get new league members eh? I'm sure most towns have these community ed course offerings. So why not contact the leadership of your club to put a course together for your town and get some new blood into your club.

Now's the time to do this!!!
Take care all,
Jerry Labrosse

NHPA Income And Expenditures December 2002/January 2003

Receipts	
Charter Dues	\$18.00
Newsline Subscriptions	\$6,155.00
Newsline Ads	\$1,544.00
Sanction Club/League Patches	\$13.00
Membership Dues	\$16,367.00
NHPF	\$50.00
Firstar Bank Interest Money Mkt	\$344.54
Firstar Bank Interest Checking	\$334.46
2004 World Tournament Payment	\$5,000.00
Logo Use Fee	\$200.00
Horseshoe Sanction Fees	<u>\$2,600.00</u>
Total	\$32,626.00
 Expenditures	
Newsline Printing Supplies & Mailing	\$4,609.23
Newsline Publication, Editing, & Miscellaneous	\$912.00
Sanction League Postage & Printing	\$141.25
Sanction League Patches & Awards	\$1,072.26
Sanction League Office Supplies & Telephone	\$16.63
Sanction League Director Allowance	\$411.00
Regional Director Allowance	\$312.00
Regional Director, Postage, Telephone, Supplies & Printing	\$742.41
Equipment Purchases, Rentals & Repair	\$205.85
Printing, Paper & Office Supplies	\$1,203.93
Postages	\$522.71
Officers Telephone	\$382.58
Officers Travel	\$570.25
Secretary-treasurer Allowance	\$3,040.00
Presidents Allowance	\$912.00
Vice Presidents Allowance	\$2,280.00
Publicity Promotions & Ads	\$756.00
Direct & Indirect NHPF Donations & Support	\$13,247.11
Insurance	\$22,280.00
Misc. Fees, Bonds, Bank Charges, Etc.	\$73.19
Refunds	\$18.00
Natstats	\$912.00
Internet Access & Web Site	<u>\$1,099.30</u>
Total	\$55,719.70
From The Books Of NHPA Secretary/Treasurer Dick Hansen	

PAUL STEWART FOR FIFTH VICE-PRESIDENT

I wish to announce my candidacy for re-election for the NHPA 5th Vice-President position. Given the opportunity and honor to serve you for another two years as your NHPA 5th Vice President, I can promise continued service and sincerity toward your enjoyment of our NHPA website and the growth of our horseshoe pitching sport.

I believe my horseshoe pitching experience and continued dedication, as an officer will justify your confidence in me. As a candidate for NHPA 5th Vice President, I respectfully ask for your vote.

Thank you,
Paul Stewart

SANCTIONED CLUB/LEAGUE REPORT by Lorraine Sternberg

The top-ten list for Sanctioned Leagues is printed in this issue. I would like to congratulate all those who made the list for 2002. As in any other sport, making the top-ten list is quite an honor.

The outstanding pitcher for the Adult National Division was Jim Walters of Ohio, taking first place in three of the four categories. Roger Albright of Missouri took first place in high point over average.

In the Men's 40-ft. distance division, Brian Simmons of Rhode Island captured a first place for high ringer average and high ringer game (97.50%). Richard Pelley of Maine received first in high ringer over average.

For the Men's 30-ft. distance division, Dee Powell received first place for high ringer average while his friend, Don Wild took first place for high ringer game. Both are from Colorado. Richard Roberts took a first place plaque for high ringer over average.

Competing for the top spot in the Women's Division was Gert Wilcziek of Wisconsin and Bev Nathe of Minnesota. Gert took a first in high ringer average. Both Gert and Bev shared first in high ringer game of 90%. Bobbie Richard of Louisiana captured first for high ringer over average.

In the Junior Boy's Division, Lance Huth of Indiana took a first in two of the three categories while Corey Hughes of Minnesota, received a first for high ringer average in both the Boy's and Junior National Division.

In the Girl's Division, there were three different girls receiving a first for each category. Melissa Bigelow of Vermont took high ringer average. Kayla Larson of Minnesota captured first for high ringer game. Sara Besaw of Wisconsin got first place for high ringer over average.

The boys dominated the Junior National Division with Pat Hovda of Minnesota taking first in high point average and high point game. Nicholas Hinman of New York took a first place in high point over average.

At our winter council meeting on January 25th, the council reviewed the list of juniors that were submitted for the NHPA Scholarships. There were a total of fourteen juniors submitted, with three of them being ineligible. There were five juniors selected for a \$200.00 scholarship each.

Those juniors receiving a scholarship and plaque were:

- Dustin Tanner** of Beloit HSC, WI
- Grade point average of 4.00
- Kayla Larson** of Alexandria HSC, MN
- Grade point average of 3.976

- Ryan Hoverson** of Sheyenne Valley Jr. Lg., ND
- Grade point average of 3.69
- Danny Cunningham** of Liberty HSC, MO
- Grade point average of 3.645
- Joseph Maestas** of Sweetwater County, WY
- Grade point average of 3.642

Juniors receiving Honorable Mention and a certificate and a patch were:

- Mark Strand** of Sheyenne Valley Jr. Lg., ND
- Neil Tafelmeyer** of Sheyenne Valley Jr. Lg., ND
- Alexandra Hagen** of Sheyenne Valley Jr. Lg., ND
- Zachary Hines** of Close Doesn't Count Jr. Lg., WI
- Chuck Harper** of Close Doesn't Count Jr. Lg., WI
- Damon Barnhart** of Try County HSC, OH

Congratulations to all of these students. If you are in need of information on the NHPA Sanctioned League Junior Scholar Pitcher awards program, you can contact me.

For those of you who will be starting up leagues soon, have a great season.

Stay Informed Keep Subscription Current

Don't let your "Horseshoe Pitching Newslines" subscription lapse. Check the expiration date on the mailing label. If it is 04/01/03, this is your last issue and you should mail a renewal now.

NHPA "Horseshoe Pitching Newslines" Subscription Renewal Form

Name _____
Address _____
City/State/Zip _____
Phone _____

New Subscriber Renewal

Subscription price for one, two, three years is
\$12.00, \$22.00, \$30.00 for standard mailing in the U.S.
Add \$8.00/yr. for First Class.
Canada is \$20.00, \$38.00 or \$54.00 (US FUNDS ONLY)

Make checks payable and mail with form to:
NHPA Secretary/Treasurer
3085 76th Street
Franksville, WI 53126

If you have missed an issue,
limited copies of most back issues are available for \$3.00.
Send all back copy requests with payment to *Horseshoe Pitching* NEWSLINE Editor,
P.O. Box 536, Webberville, MI 48892-0536

PUBLICITY PROMOTION continued from page 9

SESSION 5: We will watch some video (you choose which part and which one). Then we will practice for the last 1/2 hr.

SESSION 6: We will set up some individual competitions and calling scores will be done as per the Official Rules.

If you wish, you may join our club at the completion of this session.

Please take a few minutes and complete the questionnaire given out at the beginning of this session. We endeavor to make this class as productive as we can for as many people as possible. Your answers will dictate the itinerary of future classes.

Thank you ———(your signature or your clubs name)

HORSESHOE PITCHING CLASS FEEDBACK FORM

1. Did the class meet your expectations?

Yes____, Somewhat____, No____

2. If no, what can we do to make it better?

3. How did you hear about this class?

Newspaper____, Brochure____, Friend ____

Other _____

4. Were all your questions answered satisfactorily?

Yes____, No, ____

If no which questions?

5. Please rate the instructors 10= best (circle)

10 9 8 7 6 5 4 3 2 1

6. Did you enjoy the class? Yes ____, No ____ What was your favorite part?

7. How can we improve the instructions?

Would you please tell your friends about organized horseshoe pitching and the existence of this club? Next scheduled class is (whichever dates you've chose)

As a direct result of an Internet website guestbook entry, Virginia has been able to create a new horseshoe pitching club in their state. Many thanks go out to Kevin Snelgrove for continued follow-up with the Chesapeake Horseshoe Club. They are an enthusiastic bunch too! Welcome Chesapeake, Virginia to the NHPA! We sincerely hope you grow and prosper and wish you many ringers.

Internationally:

This time we heard from Germany. There is quite a contingent of horseshoe pitchers there. It seems they pitch in conjunction with country music, line dancing etc. Anyone wishing to view their website can do so by following this URL: <http://www.pro-country-ev.de/>

When their page comes up go on the left-hand menu and click on "hufeisen". The literal translation of this word is 'hoof iron' and is the equivalent of horseshoes. Their rules vary when compared to ours, and of course it's all in German. Besides clicking on "hufeisen" click on the links then take a look at those websites. About 50% of them include "hufeisen", some sites even call it horseshoe pitching.

Those of you not connected to the Internet are encouraged to visit your local library to view horseshoepitching.com. Those of you with Internet access are encouraged to share this media with folks who do not have access. Please ask them to sign our guestbook during their visit. In Bismark a question was posed to the delegates asking how many had seen our website. At least 80% of them raised their hands. We hope that number will increase in 2003.

Thank you to all the individuals who have sent their promotional and publicity items for me to peruse. There are very good ideas. If you've been successful at something please write it up for Newsline and share it with the rest of us. If you put it on your website please come to horseshoepitching.com and say that in the message board so others may share in your success.

The Promotion/Publicity team wishes you a substantial increase in your pitching percentage for 2003!

WORLD TOURNAMENT DATE CORRECTION

The dates for the 2003 World Tournament are August 4th through the 16th.

They were incorrectly listed in Chippewa Valley Convention and Visitors Bureau's advertisement in the last issue of "Newsline" as the 3rd through the 17th.

The entry form for the 2003 World Tournament can be found on page 14 and more information from the Chippewa Valley Convention and Visitors Bureau is on page 12 and 13.

HALL OF FAME *by Earl and Vicki Winston*

As mentioned in the last issue of Newline, time is drawing short for nominations to be considered in the 2003 voting. Again, we urge you to consider only persons who have served or played our sport at the national level for at least ten years as an adult. We require only one copy of any written material that is submitted for a nominee. It should be typewritten and sent to us at the address listed in the front of this magazine. All nominations must reach us by March 31, 2003 to be considered for this year's ballot.

We would like to make the Hall of Fame Quiz a regular feature of Newline, so here is the second installment. All answers are persons who have been inducted into the NHPA Hall of Fame and unless we make a mistake, there will be no repeats from a previous quiz. A listing of all inductees can be found on the NHPA Web site under the link HOF - Awards. Any program from a past NHPA Hall of Fame and Awards Banquet also has a listing of inductees through that year. If you don't have either of these resources - we wish you lots of luck! We continue to thank Oattie Reno Sr. and Gary Kline whose books have provided some of the information we use.

HALL OF FAME QUIZ

1. Who holds the record for the most consecutive ringers in a single world tournament game?

2. Give yourself extra credit if you can name the former NHPA President who was the losing pitcher in the game mentioned in question #1.
3. Who was the first New York pitcher to win a World Championship?
4. What two gentlemen pitched perfect games during world tournament play?
5. Who was responsible for first bringing the world tournament to Utah?
6. Who was the first World Champion to average over 70% in winning a world title?
7. Who pitched four consecutive 90% or higher games at the 1965 world tournament?
8. Who manufactured the pitching shoes that were used by Ted Allen prior to Ted manufacturing his own pitching shoes?
9. Who published a daily world tournament report during his many years as NHPA Publicity Director?
10. In the days before the use of computers, who worked alongside Francis Asher in recording all world tournament stats?
11. Who is the longtime horseshoe promoter, Game Related Items distributor and NHPA Regional Director who helped to organize the Nebraska Hall of Fame?
12. Who set the women's world tournament on-site qualifying record of 266 points for 100 shoes in 1935, a record that stood until broken by Vicki Winston in 1974?

(Answers located on page 26)

SIX PAC



HORSESHOES®

Tournament Quality

Pitched in A-Z Classes
Discount on 6 Pair or more
ONE YEAR GUARANTEE

Order Direct or
from your NHPA Representative
SIX PAC HORSESHOES
4811 Tishomingo Road
Hillsboro, MO 63050
Attn: Harvey E. Wobbe
(636) 942-3544

LORRAINE STERNBERG **THIRD VICE PRESIDENT**

I wish to announce my candidacy for re-election for NHPA 3rd Vice President.

I have just finished my second term in office and would like to continue to serve the NHPA Sanctioned League Program. I have enjoyed working with the league directors and the other NHPA officers. I feel there is still much to be done to increase our membership in sanctioned leagues and I would like to work to continue this effort in the growth of the program. I would appreciate your support for re-election at the 2003 convention.

Thank you!

THE CHIPPEWA VALLEY WELCOMES THE WORLD HORSESHOE TOURNAMENT

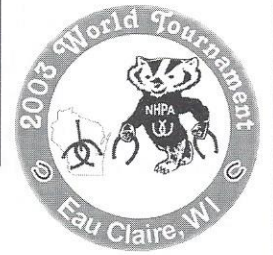

**AUGUST 4-16, 2003
EAU CLAIRE, WISCONSIN**

Welcome to the Chippewa Valley! We are nestled in the rolling hills of West Central Wisconsin along the banks of the Eau Claire, Chippewa and Red Cedar rivers. Our area consists of the cities of Eau Claire, Menomonie, Chippewa Falls, Altoona and the Town of Union. Each of these areas offers their own unique flavor - something for all visitors.

One consistent thread is our rich history and pride of our ancestry, which is evident in the many restored historic buildings and museums. The Valley is also home to hundreds of acres of parkland - offering picnic, camping and sports areas as well as places for boating, fishing and swimming.

The natural beauty of the Chippewa Valley enticed settlers years ago to live near giant stands of timber and flowing rivers. In 1837 the Chippewa Valley opened its doors to lumbering and the area flourished. Come and see the rich history left by wealthy lumber barons, hard-working immigrants, and persevering pioneers. When you visit the Chippewa Valley, you will find attractions to meet any interest - from the natural to the historic to the sublime, the educational and even the bizarre. The Chippewa Valley's vast logging history gives reason for many museums and even a replica of an 1890s logging camp. Our rural beauty and scenic rivers make agricultural attractions and breathtaking tours plentiful. You will certainly not be disappointed in the variety of things to do and see in the Chippewa Valley!

Three bicycle trails attract bikers, skaters and hikers to our area adding up to 70 miles of biking enjoyment by way of some of the most beautiful scenery in the state. The numerous golf courses throughout the area afford you the option to play a fun 9-holes or test your skills on a challenging championship course.

What vacation or getaway would be complete without a bit of shopping? In the Chippewa Valley, you will find antique shops, art galleries, specialty food shops and clothing shops, in addition to a regional mall with anchor stores like Marshall Fields, JC Penney, Scheels All Sports and Sears. Many local gift, floral and jewelry stores offer unique items to bring back home with you. Area artisans sell their creations at shops and galleries throughout the Valley. And you can't leave the area without a purchase from our favorite brewery's gift shop - Leinenkugel's Leinie Lodge.

Are you looking for fine dining, ethnic cuisine, or down-home cooking? Maybe you are hoping to sample the local brews. You will find it all in the Chippewa Valley.

Chippewa Valley Facts:

Population: 173,452

Average August Temperature: 80 Degrees Fahrenheit

Transportation:

HIGHWAYS - Eau Claire is serviced by an extensive network of Interstate, U.S. and State Highways. Interstate Highway 94, U.S. Highway 53 and State Trunk Highway 29 form the backbone of this system, providing ready access to distant locations in every direction.

AIR - The Chippewa Valley Regional Airport in Eau Claire is serviced by Mesaba Airlines (Northwest Airlink) and connects Eau Claire with the Minneapolis/St. Paul International Airport with several scheduled daily flights. For discounts on Northwest Airlines, call 1-888-523-3866, and ask for Maria Falcone.

Lodging:

HOST HOTEL: The Park Inn & Suites is Eau Claire's newest hotel! The 2003 Horseshoe convention, Junior Party, and Banquet will be held at this site. The hotel has 85 rooms and suites, all with in-room coffee makers, hair dryers, irons, full size ironing boards and 2 data ports. Suites have microwaves and refrigerators, some with in-room Jacuzzis. Features Arizona's Lounge, 24-hour indoor pool, whirlpool, exercise room, game room and guest laundry. Complimentary access to Gold's Gym, continental breakfast, and local phone calls.

Call the Chippewa Valley Convention and Visitors Bureau at 1-888-523-3866 to make your reservations today! Below is a list of hotel properties located near the site:

HOTELS	RATES	ROOMS	REST. & BAR	POOL
Days Inn West 6319 Truax Lane • Eau Claire, WI 54703	\$70.00	71	Yes	Yes
Hampton Inn 2622 Craig Road • Eau Claire, WI 54701	\$75.00	106	No	Yes
Heartland Inn 4075 Commonwealth Avenue • Eau Claire, WI 54701	\$74.00	87	No	Yes
Holiday Inn Campus Area Hotel 2703 Craig Road • Eau Claire, WI 54701	\$99.95	137	Yes	Yes
Holiday Inn Convention Center 205 South Barstow Street • Eau Claire, WI 54701	\$75.00	122	Yes	Yes
Park Inn 1009 W. Park Avenue • Chippewa Falls, WI 54729	\$89.00	67	Yes	Yes
Park Inn & Suites 3340 Mondovi Road • Eau Claire, WI 54701	\$78.00	85	Yes	Yes
Ramada Conference Center 1202 West Clairemont Avenue • Eau Claire, WI 54703	\$75.00	233	Yes	Yes

If camping is more your style, why not try Whispering Pines? Located approximately 5 miles from the pitching venue, this private campground is ready to welcome you! For just \$20 per evening, they will offer you the following amenities. Call the Chippewa Valley Convention and Visitors Bureau if you would like us to send you a map of the campground.

Amenities Include:

- 150 sites with electrical hook ups
- Water service available
- Swimming Pool
- Horseshoe pits
- FREE Hot Showers
- Fishing Pond

Honey Dew Wagon Service included in rate

Visit our web page to learn more about the 2003 World Horseshoe tournament!

www.chippewavalleysports.com

Friends of Horseshoes

Fundraising is always a challenge. Your assistance would be appreciated in helping us with the 2003 World Horseshoe Tournament. Please save all used printer cartridges and contact Maria at the number below for more information on how to help fundraise!

Donation checks can be made out to the following:
Chippewa Valley Sports Commission
3625 Gateway Dr. Suite F
Eau Claire, WI 54701

To place an ad in the 2003 program or for fundraising details, please call Maria Falcone at 1-888-523-3866

Registration Fees:

Adults \$100.00
Juniors \$25.00
Pitching Schedules
will be mailed to all
contestants by June 16th
to the address you have
listed on this form.

ENTRY FORM
National Horseshoe Pitchers Association
World Horseshoe Pitching Championships
August 4th - August 16th 2003
Eau Claire, Wisconsin

Entry Deadline May 15th 2003

NAME _____ 2003 NHPA Card # _____
(please print) First Last (or Canadian)

ADDRESS _____ SS # _____
(Optional)

CITY _____ STATE/PROV _____ ZIP/POSTAL CODE _____

Telephone: Home # _____ Work # _____ Date of Birth _____

Please list your local Newspaper _____

Circle the division you are entering - You can enter only one division (See notes near bottom of page)

OPEN MEN 40' SENIOR MEN 40' OPEN WOMEN SENIOR WOMEN 30' ELDERS JR. BOYS JR. GIRLS * JR 9 & UNDER 20'

I believe my current average is approx _____ % No refunds will be made after June 2nd 2003

PARTICIPANTS LIABILITY RELEASE: In consideration of participating in such activity, I hereby waive, release and forever discharge the National Horseshoe Pitchers Association, all officers, employees, agents and servants of the afore stated organization, and all fellow participants of this event, for any and all action, cause of action, damage, loss or injury, which I may suffer as a consequence of participating in the World Horseshoe Pitching Tournament.

SIGNED _____ DATE _____

-----mail top half only-----

We reserve the right to disallow your participation if we discover errors on this form or if your records don't appear in NatStats, CanStats, or false or misleading information is on this form.

MAIL THIS FORM with REGISTRATION FEES (PAYABLE TO NHPA)

TO: NHPA
3085 76th St
Franksville WI 53126

Direct Telephone Inquiries to:
Dick Hansen NHPA Sect/Treas
262-835-9108

All Entries must be on this form and mailed with a postmark no later than **MAY 15th 2003**. Entries received with a postmark after May 15th shall be put on a waiting list and pay an additional 20% penalty if later accepted into this event. NATSTATS/CANSTATS files must substantiate that you have pitched a minimum of four (4) sanctioned events in the preceding twelve (12) months, at your divisions pitching distance, prior to May 15th 2003, which is the last date NATSTATS will accept results to determine entering averages. Only one (1) event is required for Juniors. Participants will be required to show their 2003 NHPA or CANADIAN membership card when checking in to pitch.

REGISTRATION FEES: ALL ADULTS -- \$100.00 • ALL JUNIORS -- \$25.00 • **U.S. FUNDS ONLY**
CANADIAN ENTRIES USE MONEY ORDERS REGISTRATION FEE INCLUDES SCORE KEEPING FEES
NO REFUNDS AFTER June 2nd 2003

You may enter at anytime prior to MAY 15th. All averages used will be the average on record in NATSTATS/CANSTATS on MAY 15th, 2003

READ CAREFULLY: Any adult male pitching from the full distance platform may enter the **OPEN MEN'S DIVISION** regardless of age, just as any adult female may enter the **OPEN WOMEN'S DIVISION**. To enter the **SENIOR DIVISION**, you must be 60 years or older as of August 3rd 2003. Any individual 70 years or older or physically impaired person of any age, all of which must pitch from less than the full distance platform, may enter the **ELDERS DIVISION**. **JUNIOR DIVISION** entrants must be 18 years old or less for the entire 2003 calendar year. (* The Junior 9 and under is for juniors under the age of 10. This division will be CLASS PLAY ONLY.)

US RESIDENTS ONLY -INCLUDE a self addressed - stamped envelope if you would like a copy of your current average. This will be sent to you by NatStats. Canadian entries need to go direct to CANSTATS for their average.
The pitching schedule will be finalized by **June 2nd** and will be mailed to the address you have listed above.

JUNIOR PROMOTIONS by Heidi Poppe

Where are they now - More former junior stories

I have received so many responses in regards to the idea from Stan Griggs for past junior pitchers to share their stories that I have included several below. If you or someone you know has a junior story worth sharing, let me know!

Heidi Poppe

Walter Ray Williams, Jr. - FL

Hi Heidi,

After reading the letter that Stan Griggs sent to you, I thought I would mention a small bit about one 'rematch' I had. At this year's world tournament in Alberta, I played a gentleman who I haven't played against since we were in the Junior division in 1970. Jerry LaBrosse, who I believe is the president of the Minnesota charter, and I went a little over 32 years between matches. I have had the opportunity to play against many of my junior opponents in the men's division over the years. Tables have turned a bit in some instances as Brian Simmons regularly beats me now as opposed to many years ago. I have probably played Mark Seibold more than any other player at the world tournament having also played against him in 1970. I have also had the opportunity to play against the younger players who pitched in the junior divisions after I left it such as Alan Francis and Jim Walters. I realize that not all stay with the game, but many come back to it or stay with it, as it is truly a life long game.

It is often mentioned to me from some players who are older than I am who have been playing horseshoes for a short time

that they wish they had started the game as a youngster. I was fortunate to have been introduced when I was young and am glad that I was. I have met many wonderful people at horseshoe tournaments and that includes my wife. My three younger brothers who also grew up pitching horseshoes are still active in the game. Jonathan is the Southern California president. Nathan has won several state titles in both Arizona and California. And Jeff is capable of beating anyone when he gets his game going. Horseshoes has always been an important part of my life and I am sure that it always will be.

Walter Ray Williams, Jr.

John Passmore - MD

Hello Heidi -

I thought I'd chip in on the "Where are they now?" for former Juniors in response to your Newsline article and idea proposed by Stan Griggs. I'm anxious to hear of the responses you receive. It seems the pitchers from my generation (the mid-70's) are well represented today: WRW, Jr., Jeff Williams, Rick Howe, Brian Simmons, Doug Kienia, Steve Hohl, Robert Davis, Ken Fraser and Kevin Hollister and others.

I was a junior pitcher from 1970 to 1975. As a junior, I was four-time Indiana Junior State Champ, following the footsteps of the great Indiana Junior pitchers - Junior World Champs Mark Seibold and Bill Holland having graduated to the big leagues. My first tournament was at the age of eleven.

I pitched in the 1972, 1974 and 1975 Junior World tournaments. I finished fourth in the 1972 Greenville Ohio event at 4-3 and 75.1% with Walter Ray pitching his 89.2% tournament average that year. Doug Kienia and Alvin VinSant were second and third, respectively.

In 1974, I failed to qualify for the Championship group in Keene, NH with a disappointing 74% in the 50-shoe qualifying round. I finished second in Class B with a 70% effort.

My high game as a junior was 49 out of 50 (98%) game winning 94-0, as all games in that tournament were 50-shoe games. Other high tournaments were an 87.5%, 86.6, 85.1, 84.1 and a few others in the 80's.

The 1975 Lafayette, IN Junior WT group is regarded as the best ever. My best effort of 702 ringers out of 784 shoes broke Walter Ray's 1972 record with 89.5%. However, I had my worst game, 82% against Walter Ray's 88% and the two record breaking games vs. Rick Howe and vs. Jeff Williams to go 4-3 and another fourth place finish.

Four weeks later, I entered my first Men's tournament, the 1975 Indiana State tournament at the age of 16. In one of the toughest fields for any state tournament, I finished fifth with a ringer percentage of 70.8%. I was ecstatic to score 47 points against both Mark Seibold and Curt Day with a 78% effort in 118 shoes.

Over the next few years I averaged in the upper 60's, highlighted by qualifying (78%) for the 1977 Championship group and av-

continued on page 16

WORLD TOURNAMENT

PRIZE LIST FOR YEAR 2003

	CHAMPIONSHIP PLAY				CLASS PLAY		
	Men/Women	Sr.M/Elder	Boys	Sr.W/Girls	12	14	16
1.	\$ 4,000	\$1,500	\$600	\$600	\$300	\$300	\$300
2.	2,500	1,000	400	400	200	200	200
3.	1,800	750	300	300	150	150	150
4.	1,240	600	280	270	110	120	130
5.	1,000	500	260	230	100	110	120
6.	800	400	240	200	\$860	100	110
7.	600	350	220	\$2,000		\$980	100
8.	500	320	200				\$1,110
9.	450	300	\$2,500				
10.	400	280					
11.	360	260					
12.	320	240					
13.	280	\$6,500					
14.	240						
15.	220						
16.	200						
17.	180		Total Purse for all Championship Divisions = \$51,500				
18.	160						
19.	150		All Finalists in Championship Adult Divisions will pay added \$50 fee				
20.	140						
21.	130						
22.	120		Juniors will have all dollar winnings deposited to a Trust Fund.				
23.	110						
24.	100						
	\$16,000						

JUNIOR PROMOTIONS

continued from page 15

eraging 67.4%. Also in 1977, I had my highest percentage tournament of 75% at a tournament in New Casle, Indiana. I have almost exclusively pitched a 1 1/4 turn. Once, however, I switched to the 1 3/4 and had my highest single game from 40 feet with 90.6%. One of my most memorable games at 40 feet was in 1976 - a 128 shoe game that I lost to Jim Knisley despite an 83% effort.

In 1979, I joined the US Army. I served as an Intelligence Analyst, Instructor and Russian Linguist. Family and career became my priority for the next 20 years. This allowed very little time to keep "on" my game. However, other than a three-year tour in Germany, I have always kept in touch with the game and pitched whenever I could manage the time.

From 1979 to 1999, I averaged anywhere from 45 to 60 percent. High tournaments have been a 64% and a 66%. Highlights have been a second place to Jim Knisley in the 1998 Ainsworth Nebraska WT in Class B-1, an eighth place in the 1990 New England Championships, a top five finish in the Massachusetts State, State Championship title in Alaska and a second, a third and a fourth in my current home state of Maryland.

Finally, in June of 2001, I received a call from Dave Loucks to inquire whether I could find the time to take on a pupil in my area and help him with his game. On June 20, 2001, I was invited to the White House to offer President George W. Bush a few pointers. We had a couple of good-natured doubles games with his Chief-of-Staff, Andrew Card and White House Counsel Alfredo Gonzalez. It was my high honor to be able to represent the NHPA and horseshoes and I had a great time!

Today I am 43 years old, have three great kids and live in Frederick, MD. I currently serve as Vice President of the Maryland HPA and have written its By-Laws. I also served as President of the Alaskan HPA when I was stationed up there.

2002 was my poorest pitching performance yet. However, I have

high hopes for 2003 and beyond. My children now require less of my attention and now that I am a single guy again, I plan on dedicating a bit more time to the game I love.

Keep in touch

Yours in Horseshoes,

John Passmore

Jerry LaBrosse - MN

Hi,

I just wanted to touch base with you about the article you wrote in December. At the end you wanted adult members that were also junior members to tell their story.

I pitched as a junior from about 1965 until 1972, and won three MN state titles. I only pitched as a 40-footer until about 1976. I got married and raised three kids and didn't have time for horseshoes. In 1991 I picked up the game again, starting out in Coon Rapids and Fridley.

I actually played against Walter Ray Williams, Jr. in California at the world tournament the year he got tagged "deadeye", I believe it was 1971. When he and I played each other in the championship class in Red Deer he made a big deal out of it to the crowd, but it was fun.

He kicked my butt back then too!! Just thought I'd let you know that junior involvement is crucial to the future of horseshoes.

We have a tireless crusader in MN with Jackie Hughes. She is going to run a horseshoe class and eventually start a whole new club up in the North Branch area where she lives. I'll keep you posted on that progress.

That's all for now,

Take care Heidi

Jerry LaBrosse

INSURANCE

by Bonnie Seibold

The Insurance Certificates for each charter have been sent to your Charter secretary. I included the following in the packet.

1. A request form for added insured certificates.
2. A claim form
3. Envelope for filing claim
4. Description of General Coverage

If you need any of these forms you could contact your Charter Secretary and they could make you a copy.

Our NHPA Insurance took a big increase this year. It went up 30% over last year. We may need to start thinking of increasing our dues to cover the increases.

The New
Elmer Hohl
HORSESHOE

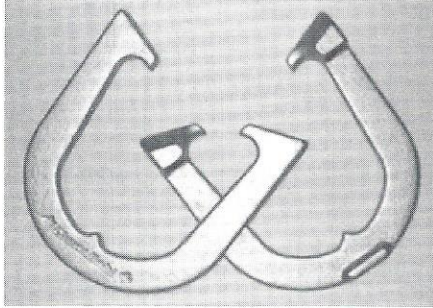

NHPA Sanctioned

Same features as the Original with improved hook design and wider opening

Available in various weights

Heat hardened points for durability

Guaranteed against breakage for one year from original date of purchase (return both shoes in original carton)

\$47.00/pair (U.S. Funds)
(shipping and taxes extra if applicable)
Order direct or from your NHPA Representative

Elmer Hohl Horseshoes
c/o Steve Hohl
380 Peel St. ♦ New Hamburg, Ontario, Canada ♦ N3A 1E5
Phone (519) 662-9584 ♦ E-mail: hohlhorseshoe@rogers.com
Champion Designed Top Quality Pitching Horseshoes

SPECIAL EVENTS CALENDAR

March 2003

22nd

5th Annual Cystic Fibrosis Fundraiser, Kemper Williams Park, Patterson, LA. Entry Fee \$20.00 Adults, \$5.00 Juniors. Everyone will receive a Cystic Fibrosis T-Shirt. Special BHPA T-Shirts to the top 3 finishers in each bracket. Pre-register by March 19. Camping at the park, 985-395-2298. For Tournament Information, contact Al Dodson, 985-385-1909, Kevin Dore', 985-395-7327, or Tim Gilmore, 985-395-5062.

April 2003

5th

Cypress Sawmill Festival MDA Horseshoe Tournament Kemper Williams Park, Patterson, LA This is a charity fund raising event for MDA. Entry fee \$15.00 Adults, \$5.00 Juniors. Special Cypress Sawmill T-Shirts to the top 3 finishers in each class. Pre-register by April 2. Camping at the park, 985-395-2298. For Tournament Information, contact Al Dodson, 985-385-1909, Kevin Dore', 985-395-7327, or Tim Gilmore, 985-395-5062

26th & 27th

36th Annual Carolina Dogwood Festival Horseshoe Tournament, Statesville, NC Jack H. Springer Horseshoe Courts. \$6,500 in Cash Prizes and Trophies. Entry Fee: \$25.00 Adults - No Entry Fee for Juniors Pre-register by March 15th - Limited to the first 190 entries. Send entry fee to: Carolina Dogwood Horseshoe Tournament, Statesville Recreation & Parks Department, P.O. Box 1111, Statesville, NC 28687-1111, contact Paul Stewart, T.D. at (704) 528-5081 for more information or go online at www.horseshoepitching.com to print an entry form from the coming events link.

May 2003

3rd & 4th

Beloit Encore

NHPA Sanctioned Singles Tournament

Edwards Activity & Sport Center, Telfer Park, Beloit, Wis.

Entry Fee - \$20.00

Entry Deadline - April 19th

8 person classes where possible. Pitch one day.

Send entries to: Earl Paulson

7105 So. County Rd H

Beloit, Wis. 53511

E-Mail: bhc.tw@wekz.net

3rd & 4th

"Best of the West" Horseshoe Tournament, Burro Inn, Beatty, Nevada. \$2,000 added prize money plus 90% return of entry fee. Championship jackets, trophies and ribbons. 12 person round robins. Two-day event. Full and short distance pitchers will be kept separate where possible. Hi-Lo Doubles on Friday. Live entertainment. Motel rates are \$30 per night, RV spots \$8 per night. Limited to 108 pitchers. Contact Don Weaver at (702)736-7348 or e-mail him at donatlasvegas@aol.com

17th & 18th

32nd Annual B.C. International, Winfield Horseshoe Club, Winfield, British Columbia Entry Deadline: May 14th. Over \$750.00 in added money / 100% payback of entry fee. Entry fee: \$15.00 (Canadian) 30' and 40' separated. Class A pay an additional \$15 and Class B pay an addition \$10. Juniors are free. All players will pitch both days. Make cheques/money orders payable to: B.C. Horseshoe Association and mail to: Sam Tomasevic, 7987 Graham Avenue, Burnaby, B.C. V3N 1V8 Canada Telephone: (604) 525-2186 and email: samtom@telus.net Entry form also available on website: www.bchorseshoe.com

24th -25th

15th Annual Elmer Hohl Ringer Classic, K.W. Khaki Club, Wellesley, Ontario, Canada Minimum of \$2,000 extra added prize money. Entry fee for Men's and Women's Championship Group: \$30.00 Canadian Entry fee for all other classes: \$20.00 Canadian

Junior entry fee is no charge if enough for a junior class, if not enough for a class they will be put in classes by average. Camping onsite. With electricity: \$12.00 Without electricity: \$9.00 Tent Site Only: \$7.00 Entry deadline: May 1st. Mail entry fees to: Wayne Becker, 308-41 Pioneer Drive, Kitchener, Ontario Canada N2P1H2 Include division and NHPA or CHPA#. Telephone: (519) 896-6670 Email: wbecker@sgci.com Send cheque or money order payable to The Khaki Tournament Fund with a stamped, self-addressed envelope or e-mail for play time.

24th - 26th

22nd Annual Head-Of-The-Mon-River Horseshoe Tournament, Fairmont, West Virginia. 100% of all entry fees is returned by purse. Purse should exceed \$5,000 for cash prizes and other awards and will be divided equally among all classes. \$25.00 Registration Fee Adults / \$5.00 Registration Fee Juniors. Deadline: Must be postmarked by May 10th. NO REFUNDS For entry form contact Beverly Tiano at Tri-County Horseshoe Club, Inc. 1133 Sunset Drive, Fairmont, WV 26554 or call (304)366-3819 or (304)282-4062. Entry form also available online at: www.horseshoepitching.com under coming events.

June 2003

27th - 29th

Eastern National Tournament, Erie, Pa. New dates. Entry \$25 plus extra \$25 for the two Championship Divisions, Adult 40' and Adult 30'. Junior division entry is free. Deadline June 14th, 2003. Contact: Chuck Burkett, 1117 East 27th St., Erie, Pa 16504, (814)455-3954, email chuckster3672@msm.com

July 2003

12th - 13th

15th Annual Open Horseshoe Tournament, Danville, Illinois. Douglas Park just off I-74 at Bowman Avenue Exit. Increased prize money from Designated "A" Sponsorship. Entry Deadline: June 27th. Register online also at: www.active.com by June 24th. Entry Fee: \$20.00 (Includes scorekeeping fees) Make checks payable to: Danville Horseshoe Club and mail to: Leo Bratland, 41 Country Club Drive, Danville, IL 61832 Phone: (217)443-5818 or email: bratld@aol.com

4th - 6th

Ringer Classic - Greenville, OH Entry fee: \$25 for adults with additional fee for Championship Class Men and Women. \$15 for Class B, Men and Women. \$10 for Class C Men. No charge for junior pitchers. Fees payable to Darke County Horseshoe Club and mail to: Mary Fleenor, 8494 Baker Road, Versailles, OH 45380. Entry deadline: June 16th

August 2003

11th

2003 Iowa State Fair Midwest Seniors Classic, Iowa State Fairgrounds, Des Moines, IA NHPA Sanctioned. Must be 60 years of age by August 11th. Over \$1,800 in prize money paid in 2002. Entry deadline: July 26th (No late entries accepted). Registration Fee: 6-Person Classes: \$15 Championship Class Fee: \$20. (Will be notified when you play) Send Entry fee of \$15 to: Dave Sidles, 1506 Wilson Avenue, Ames, IA 50010 Phone: (515) 233-1394 Email: dsidles@msn.com Tournament Director: Danny Sease, Phone: (515) 285-0131 or email: ddsease@msn.com Include with fee: Name, complete mailing address, phone number, gender, NHPA card number and pitching distance.

30th

Louisiana Shrimp & Petroleum Festival MDA Horseshoe Tournament Fundraiser. Kemper Williams Park, Patterson, LA This is a charity fund raising event for MDA. Entry fee \$20.00, Adults, \$5.00 Juniors. Payout to top 3 adult finishers in each class. Pre-register by August 27. Camping at the park, 985-395-2298. For Tournament Information, contact Al Dodson, 985-385-1909, Kevin Dore', 985-395-7327, or Tim Gilmore, 985-395-5062

THE HORSESHOE TRADER

IF YOU FIND ONE OF THESE, CALL ME!

By Bob Dunn

Howard Pintler (Peoria, Illinois) was only the second person to make application for patent of a horseshoe design. His application was dated October 22, 1921. This was prior to the popular Ohio and National Standard shoes establishing their hold of the horseshoe market. The patent was granted on January 27, 1925 and is a historic piece to our sports artifacts.

To say the very least, the draft of his shoe design is interesting. Pintler catered to the players holding the shoe in a very unorthodox method by today's standards. In 1921, most players hooked their forefinger around one of the heel calks or points of the shoe. That was the style in those days. Oh, Pinter referred to the calks as 'lugs'.

The pad addition to the blade could be beneficial to $3/4$ or $13/4$ turn pitchers, but that turn probably had not been developed yet, although George May was introducing the $11/4$ turn at national tournaments during 1920. Pintler's design probably would not benefit those pitching $11/4$ turns or the flip shoe, which was also commonplace in those days.

That design still today would be allowable as long as the NHPA granted initial sanction. There is no reason to believe that the sanctioning wouldn't be granted, as the pad on the blade is part of the original design and a constant feature of the shoe. If an individual pitcher modified a shoe by welding and adding that pad for his own purpose or advantage, then the change would not be allowed.

Pintler's patent leaves lot of questions. Did he assume all pitchers were right-handed or did he expect that left-handed players could hold the shoe upside down? Maybe he intended to also manufacture some models for left-handed pitchers? There is the question of whether his shoe ever made it to the production line? He did however, have the innovation of trying to replace the need of using the shoe off the horse to enjoy a game of horseshoe pitching. That was a mention (in part) in his application: "Such games have been

played by using cast of horseshoes, which are usually rough and have sharp edges, and are inconvenient to hold or pitch. The object of my invention is to provide an article, similar in shape and size to a horse shoe, but arranged to be easily held and pitched without liability of tearing or wearing the skin from fingers of the players."

The application made no mention of a national organization or standard shoe dimensions, so Pintler probably was not a star pitcher, or an association member, but rather a sport enthusiast who saw a potential niche to help a sport and just maybe, make a buck. There is no knowledge that a Pintler shoe exists, but that doesn't mean that someday, one won't show up. If you find one - call me.

Jan. 27, 1925.

H. L. PINTLER
GAME
Filed Oct. 22, 1921

1,524,526

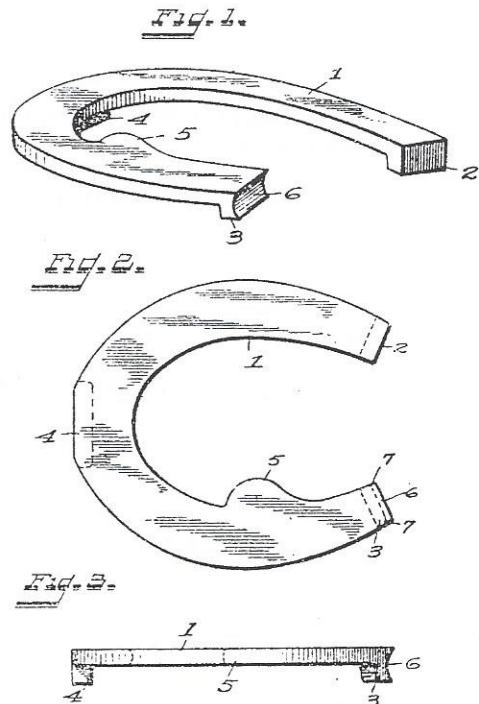

REGIONAL DIRECTORS REPORT *by Allen Baptist*

With deep regret, I will not be able to attend the World Tournament in Eau Claire this year. I recently accepted the position as General Manager for a new lumberyard that is currently under construction in Gypsum Colorado, which is only seven miles from my home. Since I am starting with a new company, I am not eligible for any time off for one year. This is the first WT I will have missed in 15 years. Ward Lutz, Regional Director from Minnesota will be running the shoe checks for me. Ward has helped me with shoe checks since I have been in charge of it. I would like for all of the Regional Directors who attend the World Tournament this year to give Ward all of the assistance you can. This needs to be a team effort.

From the Mail Bag

Randy Collins, Texas Regional Director - reports that Texas has 49 sanctioned tournaments scheduled for 2003, with two of them being hosted by their new club in Kilgore.

Bernie VanLerberg, Kansas Regional Director - reports that he has sanctioned existing courts in Belleview Kansas. There are 10 outside clay courts that also have lights.

Kevin Snelgrove, Virginia Regional Director - reports that Virginia has experienced tremendous growth this last year. Over 100 new members and four new sanctioned clubs have joined their ranks. Four prospective clubs are also in the works in Fulks Run, Lynchburg, Portsmouth and Crozet. Kevin says that the 2nd Chesapeake Open was a huge success and it spawned the newly formed Portsmouth Horseshoe Club spearheaded by Donnie Snowden. The club is petitioning the park to build some new courts. The National Senior Games will be held at the Chesapeake City Park, which will be directed by Al Sandham who is the president of the Georgia Horseshoe Pitchers Association. Virginia will host 35 sanctioned tournaments in 2003.

Steve Summerlin, Michigan Regional Director - reports that Michigan had a very successful 2002 with having their largest State Tournament in the last four years. Michigan's membership has not changed, but their numbers are holding steady. A new sanctioned league was added last year but unfortunately, it was in an indoor facility that they have lost the use of. Steve is working with a gentleman in Port Huron that wants to build a four-court arena and also start a league. The plans have been submitted to the planning committee for approval. Steve is also working with

a person who wants to build a world-class facility with 20 courts and a lot of amenities attached to the end of a bowling alley that he owns. The planning is in the early stages but it looks very promising. The Adrian horseshoe club lost their facility at the fairgrounds a year ago and is in the process of rebuilding at the local conservation club. They have six courts and hope to have another six by fall. Their goal is to have 19-lighted courts to host the state tournament again. Michigan has 73 tournaments and two sanctioned leagues on tap for 2003.

Ron Latiolais, Louisiana Regional Director - reports that they have 29 sanctioned tournaments scheduled for this year. They also have a new club that is located in Belle River. Belle River has two tournaments already scheduled for this year including a new league.

Myrtle May Kamoku, Hawaii Regional Director - reports that they have 12 new courts located in Hilo, Hawaii at the Onekahaka Beach Park. The opening dedication for the courts was canceled due to heavy rains and surf up to 20 feet. However, the courts did survive and they rescheduled the dedication for February 1st.

Don Weaver, Nevada Regional Director reports - that the Burro Inn in Beatty had three outstanding tournaments this year. John Bass and his staff gave them the usual royal treatment. Don received a call from a gentleman who lives at the McDonald ranch who wanted some info on horseshoes. He is organizing a club out there with seven or eight folks who want to pitch. Don will be meeting with him in the near future and furnish him with rules and materials for their new club.



"THE SHOE THAT FITS"
DESIGNED AND BALANCED FOR THE FLIP

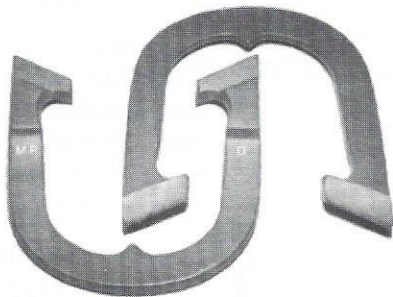

or Order from:
Your NHPA Representative
EDWARD A. DOMEY 508/865-9477
P.O. BOX 298, SUTTON, MASSACHUSETTS 01590

THE TOE OF THE MR. D SHOE IS SMOOTH WITH A GOOD SLANT ON THE TOP SIDE FOR AN EASY GRIP AND A SOFT TOUCH DELIVERY

THE CALK ON THE BOTTOM OF THE MR. D SHOE WILL INTERLOCK ONTO THE TOP OF THE FIRST SHOE PITCHED, TO HELP PREVENT THE SECOND SHOE FROM REBOUNDED BACK OFF THE STAKE



www.geocities.com/mrdshoes

— Order Direct From —
MR. D. HORSESHOES, BOX 394, POST, TX 79356



JOHNNY DAVENPORT
806/495-2630



MASTERCARD & VISA ACCEPTED

\$50 per pair
Plus \$8.00 shipping & handling to the 48 contiguous states
(May be more elsewhere)
Texas residents add 7 1/4% sales tax

— L-M-H Weights —
With or Without Ringer Breaker

CAST FROM ALLOY STEEL
Guaranteed one year against breakage
(From original date of purchase)
NO SHOES SENT ON CONSIGNMENT

NEWSLINE 19

HORSESHOE PITCHING TO BE FEATURED ON TELEVISION

Submitted by Coyce Allen - Carrollton Horseshoe Pitching Club

The Carrollton Horseshoe Pitching Club has been invited to participate in an exposition show on April 4th-6th to help promote outdoor activities. The event is being promoted by Belo Corporation., which owns WFAA Channel 8 in Dallas and the Dallas Morning News along with television stations in seventeen other markets across the nation. They have created a new division to promote consumer events in each of their television markets. Belo also increases the number of markets where events are produced; they plan to take the Better Living Flower and Outdoor Show to additional markets in the future. Plans are to have the show in 2-3 markets in 2003, 3-4 in 2004 and 6+ markets in 2006.

Their plan is to furnish us with a 10' x 10' draped booth for a discounted rate and set up a pitching demonstration area. I have offered to provide a regulation set of portable courts for use in the demo area. We will need to provide brochures and any other types of promotional items to give away. We are planning to set up something similar to what was featured on the cover of the Jan./ Feb. 2003 issue of the NHPA Newsline. I will check on setting up a NHPF donation can in our booth. We will not be able to sell any merchan-

dise, as this is one of the requirements for getting the booth at the discounted price.

Plans are to have televised contests with local news anchors to help draw the viewers to our booth while attending the event. Other suggestions are to have a ringer contest between the attendees of our demonstration sessions and to get local sporting good stores to supply gift certificates. They are hoping for ideas and suggestions from the THPA/NHPA members as to how best support/ promote our sport.

I would like to extend an invitation to any NHPA members that would like to attend, to come give support and preview the event for future promotion possibilities in other areas of the nation. As you can see, this event may be the national publicity tool that we have been searching for. The DFW show is planned to be an annual event each spring. What better time to recruit new members!

You can learn more about Belo Corporation and the upcoming event at www.belocorp.com or you can contact by email at:

CVAllen1156@aol.com or phone: (972) 466-0064

DIRECTOR OF THE YEAR 2002

Pat Wemhoff

Pawnee Ringer Horseshoe Club, Nebraska

I started pitching organized horseshoes in the spring of 1982. My neighbor living across the street invited me to league. Whoever wanted to pitch at that time just showed up, paired up and pitched partners. A couple of weeks later the Pawnee Ringer Horseshoe Club was formed. We had three-man teams pitching thirty-two-shoe games. The next year, I was appointed league statistician. Our league grew and in 1990 we voted to be a sanctioned club. Since I did the stats, I was the league director. I had fourteen columns to complete for each pitcher on the stats sheet. It took me about two and one-half hours

to fill everything out each week. Then we got a computer and my wife helped me make a worksheet; now twenty minutes tops and I'm done.

The first end of the year report I sent to Bev Born, "rest her soul" came back with red marks all over it. I was really surprised the Fri-

day after Thanksgiving when I received the 2002 Director of the Year Award.

Sportsmanship first,
Pat Wemhoff, Nebraska RD

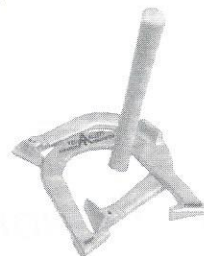
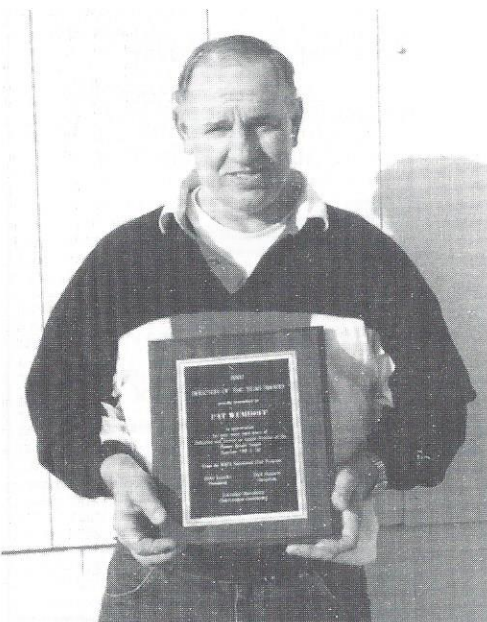

Ted Allen Horseshoes

Since 1938

Designed and pitched by Ted Allen
10 Time World Champion & record holder of
36 Consecutive Doubles (72 Ringers)

Hardness:
Dead Soft
Medium Soft
Medium Hard

Five Weights: 2 lb. (6 to 10 oz.)
Matched within 1/10 oz.
Color: Gold, Silver, Blue, Red,
White, Yellow & others

2 year guarantee against breakage

Ted Allen Horseshoes, Inc.
13299 E. County Line Rd
Longmont, CO 80504-9797

1-800-883-2129

tah_inc@yahoo.com

Made with Pride
in the USA



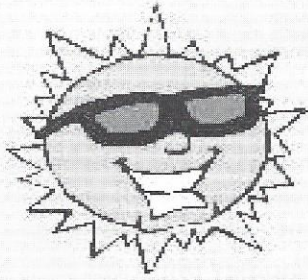

2003 SummerFun Horseshoe Tournament

8th Annual

2003 SummerFun Horseshoe Tournament
Newberry, South Carolina

Saturday & Sunday, August 16th – 17th

Sponsored by: SCHPA and Newberry Parks and Recreation

Marion-Davis Park

\$4,000 in Cash, Prizes and Trophies

Limited to 120 players

Entry Fee \$20

Deadline for Entries, August 4th

Doubles tournament on Friday night prior to tournament

Entry forms available at: www.geocities.com/sc_hpa

www.horseshoepitching.com (coming events)

or contact tournament director:

Ron Taylor at (803) 584-1453

or email: hawgjawtaylor@aol.com

Make checks to: SummerFun Horseshoe Tournament

Mail to:

Ron Taylor

1915 Molly Circle

York, SC 29745

NHPA **INTERNET WEBSITE** *by Paul Stewart*

www.horseshoepitching.com

We have been promising video clips on the NHPA Website since last years world tournament and we finally have some there now. We have started with the juniors and have posted nine short video clips. Check out the Junior Corner link where you will find a video link.

Video files are huge files and we have tried to cut the clips down as short as possible and as small of a file as possible. If you are using a dial up modem with less than 56k or if you have a slow server then it will take a little time for these files to download. Please be patient and we hope the clips are worth the wait. If you are using DSL or cable connection then you will have no problem downloading these video files. We have chosen to use Real Player to view these videos. If you don't have Real Player on your computer there is a link at the top of the Video page where you can go download a free version Real Player.

We will be continuing to add more video clips to the website as we get them prepared. All this is very time consuming and we are learning how to edit and process video as we go. We have had to upgrade our computers to bigger

and multi hard drives and add video drives and video editing software to handle and process these files. I am sure the quality of these video clips will improve as we learn more and the video technology improves.

Recently I have had several people send me emails about not being able to view the entire NHPA website since we have changed to our new look on the page. In most all cases where you are not able to view the entire page the problem is that you need to update your Internet browser. Internet Explorer and Netscape both have free downloads for an updated version of their browsers and I am sure that most all other Internet browsers have the same free upgrades. We are sorry if you are having problems, but all the changes we have been making are necessary for us to keep everything running smooth and keep up with all the code changes that occur regularly with new and improved technology.

Check us out often. It might surprise you who you will see in the movies.

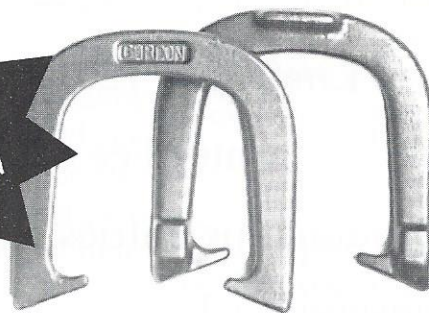

Gordon Gold or Standard Pitching Horseshoes

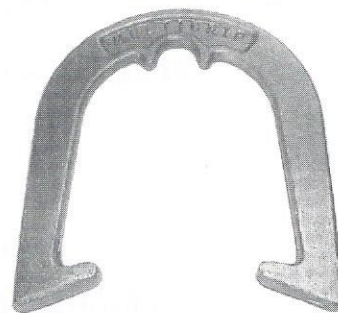

Gordon Multi-Grip Pitching Horseshoes

The forged shoe used by champions since 1932.

Gordon Standard Pitching Horseshoes are made of Carbon Steel and guaranteed against breakage for one full year from date of purchase. Gordon Gold Horseshoes are produced of Alloy Steel, heat treated for maximum toughness and guaranteed for two full years from date of purchase.

Gordon Multi-Grip Horseshoes have the staying power and twice the stability of any shoe on the market today. The Multi-Grip was designed for flip pitchers and turn pitchers with balance points conducive to consistent pitching from a variety of grips.

To purchase, send check or money order to:

Gordon Horseshoes
c/o Queen City Forging Co.
233 Tennyson St., Cincinnati, Ohio 45226

Call Toll Free: **1-888-321-7200**

e-mail order to: gordon@qcforge.com
Visit us at <http://www.gordonhorseshoes.com>



Made in U.S.A.
NHPA Approved

Danville, Illinois'

15th Annual Open

Horseshoe Tournament

July 12 & 13, 2003

AWARDS:

Class "B" and below
 1st = \$75.00 and Plaque
 2nd = \$50.00
 3rd = \$40.00
 4th = \$20.00

Designated "A" Sponsorship brings awards to:
 1st = \$550.00 and Plaque 5th = \$80.00 9th = \$40.00
 2nd = \$300.00 6th = \$70.00 10th = \$30.00
 3rd = \$200.00 7th = \$60.00 11th = \$20.00
 4th = \$100.00 8th = \$50.00 12th = \$20.00

(Class "A" 30 ft. and 40 ft. play Saturday evening and Sunday afternoon.)

FREE MONOGRAMMED TOWEL TO ALL ENTRANTS

COURTS: 20 Court layout with full walkways. Located in Douglas Park just off I-74 at Bowman Ave. exit.

ENTRY DEADLINE: June 27th. Register online also at: www.Active.com by June 24th.
 (Specific day requests considered but not guaranteed.)

ENTRY FEE: \$20.00 (includes scorekeeping fees). Make checks payable to: Danville Horseshoe Club. Prepayment preferred.
 Scorekeepers to be paid \$2.00 per game.

SANCTION: 29-03-001

SEND ENTRIES TO:

Leo Bratland
 41 Country Club Dr.
 Danville, IL 61832
 217-443-5818 (home)
 E-mail: bratlnd@aol.com

Martin Drummond
 Box 195
 Perrysville, IN 47974
 765-793-4075 (home)

PAST DANVILLE CHAMPS:

1989 - 1 st Annual Open	Tari Powell, Rossville, IL	73.5%
1990 - 2 nd Annual Open	Sandy McLachlin, Dresdon, Ont., Can.	84.5%
1991 - Spring Open	Tari Powell, Rossville, IL	79.8%
1991 - 3 rd Annual Open	Tari Powell, Rossville, IL	79.6%
1992 - 4 th Annual Open	Don Peters, Chenoa, IL	59.6%
1992 - August Open	Walter Ray Williams, Jr., Stockton, CA	83.0%
1993 - 5 th Annual Open	Larry Knop, Verona, IL	69.0%
1993 - August Open	Tari Powell, Rossville, IL	80.0%
1994 - 6 th Annual Open	Randy Hankins, Prospect, KY	63.8%
1994 - August Open	Cliff Baker, Sheldon, IL	72.3%
1995 - Pepsi Open	Dennis Reid, Bridgeview, IL	60.4%
1995 - 7 th Annual Open(Cocoa Cola)	Robert Hatten, Neoga, IL	70.7%
1996 - 8 th Annual Open	rained out	-----
1997 - 9 th Annual Open	Cliff Baker, Sheldon, IL	74.3%
1998 - 10 th Annual Open	Cliff Baker, Sheldon, IL	40 ft. 70.3%
	Curly Seibold, Huntington, IN	30 ft. 78.9%
1999 - 11 th Annual Open	Walter Ray Williams, Jr., Ocala, FL	40 ft. 86.1%
	Amy Francis, Defiance OH	30 ft. 84.1%
2000 - 12 th Annual Open	Mark Seibold, Huntington, IN	40 ft. 72.6%
	Robert Logan, Kouts, IN	30 ft. 79.9%
2001 - 13 th Annual Open	Alan Francis, Defiance, OH	40 ft. 85.4%
	Robert Logan, Kouts, IN	30 ft. 86.7%
2002 - 14 th Annual Open	Alan Francis, Defiance, OH	40 ft. 86.1%
	Robert Logan, Kouts, IN	30 ft. 79.0%

SANCTIONED LEAGUE 2002 TOP TEN LIST

Adult National Division-Mixed Distance

High Point Average

Pos.	Name	Club/State	Pts.
1.	Jim Walters	Troy, OH	126.40
2.	Paul LaCrosse	Denver Metro, CO	121.97
3.	Mark Mauthe	Platteville, WI	118.58
4.	Connie Filley	Red River Valley, ND	117.61
5.	Dee Powell	Denver Metro, CO	116.58
6.	Don Wild	North Weld, CO	115.92
7.	Jim Cooper	Arledge's Indoor, OH	113.13
8.	Mary Ann Kramr	Riverside, TX	112.42
9.	Stan Griggs	Kansas City Heart of America, MO	112.04
10.	Loree Meier	Liberty, MO	111.50

High Point Game

1.	Jim Walters	Troy, OH	141
2.	Don Wild	North Weld, CO	138
3.	Paul LaCrosse	Denver Metro, CO	135
4.	Mark Mauthe	Platteville, WI	134
5.	Rich Pintor	Denver Metro, CO	134
6.	Jim Cooper	Whetstone, OH	133
7.	Connie Filley	Red River Valley, ND	131
8.	John Martin	Arledge's Indoor, OH	131
9.	Archie Matheny	North Central Ark., AK	131
10.	Mary Green	Try County, OH	130
10.	Stan Griggs	Kansas City Heart of America, MO	130

High Point Over Average

1.	Roger Albright	Pony Express, MO	40.83
2.	Barry McClure	Madison County, KY	37.90
3.	Bill Tedrick	Bryan, TX	37.89
4.	Robert Gidel	Moline, IL	36.00
5.	Margaret Tyrie	St. Moritz, MA	35.93
6.	Kenneth Brown	Pony Express, NE	35.87
7.	Nancy Husted	Glenburn, ND	35.10
8.	Nelson Yoder	Fulton County, OH	34.80
9.	Ken Triphahn	AVF Downers Grove, IL	34.38
10.	Jason Haren	Try County, OH	34.35

High Ringer Average

1.	Jim Walters	Troy, OH	79.23
2.	Gert Wilcziek	Eau Claire, WI	76.87
3.	Paul LaCrosse	Denver Metro, CO	75.31
4.	Bev Nathe	Tri-County, MN	73.79
5.	Connie Filley	Red River Valley, ND	73.33
6.	Mark Mauthe	Platteville, WI	72.00
7.	Dee Powell	Denver Metro, CO	70.00
8.	Don Wild	Denver Metro, CO	69.51
9.	Stan Griggs	Kansas City Heart of America, MO	68.08
10.	Bob Snyder	Denver Metro, CO	66.60

Men's Division - 40-ft. Distance

High Ringer Average

1.	Brian Simmons	Little Rhody, RI	81.98
2.	Jim Walters	Troy, OH	79.23
3.	Paul LaCrosse	Denver Metro, CO	75.31
4.	Branson Miller	Winchester, VA	73.28
5.	Mark Mauthe	Platteville, WI	72.00
6.	Stan Griggs	Kansas City Heart of America, MO	68.08
7.	Bob Snyder	Denver Metro, CO	66.60
8.	Jerry Wtkle	Mountaineer, WV	66.00
9.	Rich Pintor	Denver Metro, CO	65.56
10.	Chris Paul	Bryan, TX	65.55

High Ringer Game

1.	Brian Simmons	Little Rhody, RI	97.50
2.	Jim Walters	Troy, OH	92.00
3.	Mark Mauthe	Platteville, WI	88.00
4.	Darrel Taulbee	Classic City, IN	86.66
5.	Paul LaCrosse	Denver Metro, CO	86.00
6.	John Martin	Arledge's Indoor, OH	86.00
7.	Branson Miller	Winchester, VA	86.00
8.	Jim Cooper	Whetstone, OH	84.00
9.	Stan Griggs	Kansas City Heart of America, MO	84.00
10.	Rich Pintor	Denver Metro, CO	84.00

High Ringer Over Average

1.	Richard Pelley	Loon Pond, MA	39.45
2.	Stan Loy	Classic City, IN	34.27
3.	Willie Lothamer	Classic City, IN	34.12
4.	Jim Shilling	Classic City, IN	32.94
5.	Bill Larson	Brooklyn Park, MN	31.93
6.	Jim Lemish	Classic City, IN	31.55
7.	Ron Parrish	Classic City, IN	31.28
8.	Art Ullom	Classic City, IN	31.18
9.	Robert Whipp	Loon Pond, MA	30.44
10.	Larry Bryce	Shreveport, LA	30.09

Men's Division - 30-Ft. Distance

High Ringer Average

1.	Dee Powell	Denver Metro, CO	70.00
2.	Don Wild	Denver Metro, CO	69.51
3.	Marv Meyer	Rochester, MN	65.50
4.	Archie Matheny	North Central Ark., AK	65.12
5.	Clayton Gage	Close Doesn't Count, WI	63.75
6.	Curly Seibold	Marion, IN	63.67
7.	Gordon Carlson	Denver Metro, CO	63.62
8.	Lloyd Wolf	Tri-County, MN	63.50
9.	Ralph Weigle	New Cumberland, PA	63.33
10.	Joe Rinehart	New Cumberland, PA	61.17

High Ringer Game

1.	Don Wild	North Weld, CO	88.00
2.	(tie)Dee Powell	Denver Metro, CO	86.00
2.	(tie)Lloyd Wolf	Tri-County, MN	86.00
3.	Clayton Gage	Close Doesn't Count, WI	85.00
4.	Archie Matheny	North Central Ark., AK	84.00
5.	Marv Meyer	Rochester, MN	82.00
6.	Gordon Carlson	Denver Metro, CO	80.00
7.	Ottie Reno	Arledge's Indoor, OH	80.00
8.	Don Craig	Kansas City Heart of America, MO	76.00
9.	Tony Paiz	Denver Metro, CO	76.00
10.	Curly Seibold	Marion, IN	76.00

High Ringer Over Average

1.	Richard Roberts	Classic City, IN	40.96
2.	Robert Gidel	Moline, IL	35.09
3.	Andy Pejko	Albany, GA	28.97
4.	Wayne Mead	Kansas City Heart of America, MO	26.86
5.	Edward Bell	Moline, IL	25.42
6.	Dean Jameson	Pony Express, MO	25.29
7.	Don Bollock	Marion, IN	24.97
8.	Don Craig	Kansas City Heart of America, MO	24.87
9.	Vaughn Cummings	Marion, IN	24.78
10.	Roy Lyons	Whetstone, OH	24.19

SANCTIONED LEAGUE 2002 TOP TEN LIST

Women's Divison

High Ringer Average

1. Gert Wilcziek	Eau Claire, WI	76.87
2. Bev Nathe	Tri-County, MN	73.79
3. Connie Filley	Red River Valley, ND	73.33
4. Tamara Burke	Winchester, VA	70.54
5. Loree Meier	Liberty, MO	66.43
6. Deborah Michaud	Loon Pond, MA	66.40
7. Mary Ann Kramr	Riverside, TX	66.33
8. Lu Cave	Tri-County, MN	63.13
9. Lisa Maille	Nashua, NH	62.44
10. Mildred Romero	Denver Metro, CO	62.29

High Ringer Game

1. (tie)Bev Nathe	Tri-County, MN	90.00
2. (tie)Gert Wilcziek	Eau Claire, WI	90.00
3. Tamara Burke	Winchester, VA	86.67
4. Connie Filley	Red River Valley, ND	82.00
5. Pam Henderson	Independence, MO	82.00
6. Deborah Michaud	Loon Pond, MA	82.00
7. Mary Green	Try County, OH	80.00
8. Mary Ann Kramr	Riverside, TX	80.00
9. Lisa Maille	Nashua, NH	80.00
10. Joanne Martin	Nashua, NH	80.00

High Ringer Over Average

1. Bobbie Richard	Cajun, LA	33.56
2. Nancy Dupree	Moose Lodge #2239, LA	29.71
3. Ida Hostrup	Close Doesn't Count, WI	29.48
4. Laura Lindsey	Shreveport, LA	28.71
5. Jane Smith	Close Doesn't Count, WI	28.48
6. Shirley Sprague	Central IA. Traveling Ig., IA	27.55

7. Nancy Husted	Glenburn, ND	27.40
8. Carol Sanford	Arledge's Indoor, OH	27.27
9. Nelda Addison	Shreveport, LA	26.58
10. Cindy Dodson	Arledge's Indoor, OH	26.16

Sanctioned Junior League 2002 Top Ten List

National Division-Mixed Boy/Girls

High Point Average

Pos	Name	Club/State	Pts.
1.	Pat Hovda	Rochester, MN	91.78
2.	Ryan Hoverson	Sheyenne Valley Jr., ND	81.28
3.	Mark Strand	Sheyenne Valley Jr., ND	80.20
4.	Cole Grimm	Try County, OH	78.73
5.	Justin Engelhardt	Riverside, TX	76.56
6.	Blake Graeber	Riverside, TX	75.13
7.	Jordan Carr	Sheyenne Valley Jr., ND	70.00
8.	Jared Graeber	Riverside, TX	67.30
9.	Todd Bettermann	Alexandria, MN	65.73
10.	Joseph Thomsen	Platte Valley, NE	62.28

High Point Game

1.	Pat Hovda	Rochester, MN	110
2.	Ryan Hoverson	Sheyenne Valley Jr., ND	106
3.	Cole Grimm	Try County, OH	103
4.	Justin Engelhardt	Riverside, TX	100
5.	Jared Graeber	Riverside, TX	95
6.	Mark Strand	Sheyenne Valley Jr., ND	91
7.	Blake Graeber	Riverside, TX	89
8.	Kayla Larson	Alexandria, MN	89
9.	Todd Bettermann	Alexandria, MN	88
10.	Daniel Westfield	Riverside, TX	88

continued on page 26



★ PITCHED BY CHAMPIONS ★

**Price Per Pair
Up to 12 Pairs**

CLYDESDALES	\$40.00
N.T.	\$40.00
REGULAR	\$40.00
E-Z GRIP	\$45.00
CLYDESDALE DF	\$45.00

(Write for greater quantity prices.)

**ALL "DEADEYES"
IN VARIOUS WEIGHTS OF
LIGHT - MEDIUM - HEAVY**

(Each pair matched to equal weight)

**UPS shipping included in new prices—
Continental U.S. ONLY**

**All "DEADEYES" are
now available in Med. Hard**

**E-Z Grips and N.T.s are now guaranteed for
2 years from date of original purchase.**

N.T.s now have better hooks and more weight to the front.

**All other new sanctioned "DEADEYES"
are guaranteed one year.**

Guarantee valid in Continental U.S. only.

Broken Shoe Replacement honored by manufacturer only.
Return both shoes in original box.

Contact Bill Courtwright (ONLY) for special prices on
rejects and returned shoes (NO GUARANTEE) and not for
sanctioned tournament use.

NO SHOES WILL BE SENT ON CONSIGNMENT

Missouri residents add State sales tax.

Deadeye Horseshoes c/o W. Courtwright
2250 North Lark Dr., Fenton, MO 63026
Ph: (636) 376-5222 or (636) 677-2200 (8-5)

**Order direct or from
an authorized NHPA distributor**

NHPA NATIONAL BUYER

Edward A. Domey

P.O. Box 298, Sutton, MA 01590

(508) 865-9477

SANCTIONED LEAGUE 2002 TOP TEN LIST *continued from page 25*

High Point Over Average

1. Nicholas Hinman	Syracuse Pioneer Jr., NY	37.36
2. John Stines	Try County, OH	33.83
3. Noah Elich	Edgewater, CO	31.62
4. Kayla Larson	Alexandria, MN	29.50
5. Daniel Westfield	Riverside, TX	28.19
6. Jared Graeber	Riverside, TX	27.70
7. Ryan Hoverson	Sheyenne Valley Jr., ND	24.72
8. Michael Bowman	Lions Park, MO	24.43
9. Cole Grimm	Try County, OH	24.27
10. Cassie Archer	Arkansas Valley, AR	23.25

High Ringer Average

1. Corey Hughes	Forest Lake, MN	51.49
2. Pat Hovda	Rochester, MN	51.11
3. Nick Preston	Sodbuster, VT	50.84
4. James Fortune	Central IA. Traveling, IA	49.26
5. Blake Graeber	Riverside, TX	41.00
6. Mark Strand	Sheyenne Valley Jr., ND	40.80
7. Justin Engelhardt	Riverside, TX	40.35
8. Ryan Hoverson	Sheyenne Valley Jr., ND	38.71
9. Cole Grimm	Try County, OH	38.09
10. Ryan Rademacher	Greater Lansing, MI	38.08

Junior Boy's Division

High Ringer Average

1. Corey Hughes	Forest Lake, MN	51.49
2. Pat Hovda	Rochester, MN	51.11
3. Nick Preston	Sodbuster, VT	50.84
4. James Fortune	Central IA. Traveling, IA	49.26
5. Lance Huth	Stroh, IN	49.06
6. Blake Graeber	Riverside, TX	41.00
7. Mark Strand	Sheyenne Valley Jr., ND	40.80
8. Justin Engelhardt	Riverside, TX	40.35
9. Ryan Hoverson	Sheyenne Valley Jr., ND	38.71
10. Cole Grimm	Try County, OH	38.09

High Ringer Game

1. Lance Huth	Stroh, IN	86.70
2. Nick Preston	Sodbuster, VT	78.00
3. James Fortune	Central IA. Traveling, IA	77.50
4. Corey Hughes	Forest Lake, MN	74.00
5. Pat Hovda	Rochester, MN	66.00
6. Ryan Rademacher	Greater Lansing, MI	62.50
7. Erick Baker	Stroh, IN	60.00
8. Erik Harjo	Tenn-us-see, OK	60.00
9. Justin Engelhardt	Riverside, TX	58.00
10. Ryan Hoverson	Sheyenne Valley Jr., ND	58.00

High Ringer Over Average

1. Lance Huth	Stroh, IN	37.64
2. Josh Marlowe	Bureau Valley Jr., IL	35.33
3. Chris Blanford	Bureau Valley Jr., IL	28.25
4. James Fortune	Central IA. Traveling, IA	28.24
5. Nick Preston	Sodbuster, VT	27.16
6. Erik Harjo	Tenn-us-see, OK	26.03
7. Tim Lehner	Close Doesn't Count Jr., WI	25.00
8. Ryan Rademacher	Greater Lansing, MI	24.42
9. Brandon Birr	North Mankato, MN	23.81
10. J.T. Shofner	Bureau Valley Jr., IL	23.56

Junior Girl's Division

High Ringer Average

1. Melissa Bigelow	Sodbuster, VT	27.15
2. Kayla Larson	Alexandria, MN	26.80
3. Cassie Archer	Arkansas Valley, AR	18.50
4. Sara Besaw	Wolf River, WI	15.60
5. Heather Drozd	Pawnee Ringers, NE	14.47
6. Cola Heckethier	Close Doesn't Count Jr., WI	13.69
7. Kimberly Mabry	Frederick, MD	12.63
8. Laryssa Stanton	Liberty, MO	11.25
9. Molly Losey	Bureau Valley Jr., IL	10.56
10. Torri Selleck	Sodbuster, VT	10.32

High Ringer Game

1. Kayla Larson	Alexandria, MN	50.00
2. Sara Besaw	Wolf River, WI	47.00
3. Melissa Bigelow	Sodbuster, VT	38.00
4. Cassie Archer	Arkansas Valley, AR	30.00
5. Heather Drozd	Pawnee Ringers, NE	30.00
6. Cola Heckethier	Close Doesn't Count Jr., WI	30.00
7. Nicole Lilly	Rockford, MN	28.00
8. Kimberly Mabry	Frederick, MD	28.00
9. Torri Selleck	Sodbuster, VT	24.00
10. Molly Losey	Bureau Valley Jr., IL	23.30
10. Melissa Read	Bureau Valley Jr., IL	23.30

High Ringer Over Average

1. Sara Besaw	Wolf River, WI	31.40
2. Kayla Larson	Alexandria, MN	23.20
3. Nicole Lilly	Rockford, MN	20.40
4. Cola Heckethier	Close Doesn't Count Jr., WI	16.31
5. Heather Drozd	Pawnee Ringers, NE	15.53
6. Kimberly Mabry	Frederick, MD	15.37
7. Melissa Read	Bureau Valley Jr., IL	15.37
8. Torri Selleck	Sodbuster, VT	13.68
9. Molly Losey	Bureau Valley Jr., IL	12.74
10. Cassandra Hagen	Sheyenne Valley Jr., ND	11.75

HALL OF FAME QUIZ

ANSWERS

1. Ted Allen with 72 consecutive ringers.
2. Cletus Chapelle
3. Lorraine Thomas
4. Guy Zimmerman and Elmer Hohl
5. Arch Stokes
6. C. C. Davis averaged 70.2% in winning the 1928 world tournament.
7. Floyd Toole
8. John Gordon
9. Bob Champion
10. Vincent Yannetti
11. Don Koso
12. Esther James

LIFETIME RECORDS OF CARL STEINFELDT

by Bart Sargent

Others that I would like to thank are Walter Ray Williams, Jr., Ottie Reno, Donnie Roberts and Kevin Cone. In this issue, I am submitting the lifetime records of Carl Steinfeldt

Year	Class		Position	Wins	Losses	Ringers	Shoes	Percent
1953	Men's Championships	-Qual. 584	8	23	12	1879	2642	71.1
1954	Men's Championships	-Qual. 508	5	11	6	1130	1408	80.2
1955	Men's Championships	-Qual. 500	5	27	8	2202	2842	77.5
1960	Men's Championships	-Qual. 538	4	28	7	2330	2842	82.0
1962	Men's Championships	-Qual. 504	11	22	13	2373	2994	79.3
1963	Men's Championships	-Qual. 498	3	29	6	2238	2802	79.9
1964	Men's Championships	-Qual. 558	2	30	5	2767	3316	83.4
1965	Men's Championships	-Qual. 521	6	28	7	2465	2946	84.0
1967	Men's Championships	-Qual. 523	8	24	11	2229	2818	79.1
1968	Men's Championships	-Qual. 560	5	28	7	2729	3294	82.8
1972	Men's Championships	-Qual. 559	12	21	14	2477	3168	78.2
1974	Men's Championships	-Qual. 519	2	30	5	2362	2934	80.5
1976	Men's Championships	-Qual. 541	1	33	2	2389	2894	82.6
	World Champion	Playoffs		2	1	275	326	84.4
1977	Men's Championships		4	21	5	1912	2284	83.7
1978	Intermediate Champion		1	7	0	302	354	85.3
1979	Men's Championships	-Qual. 521	4	24	7	2030	2526	80.4
1980	Men's Championships	-Qual. 539	3	26	5	1883	2396	78.5
1981	Prelims		1	11	0	469	550	85.3
	Men's Championships		2	21	2	1663	1994	83.4
1982	Prelims		1	6	1	275	350	78.6
	Men's Championships		6	15	8	1079	1388	77.7
1984	Prelims		1	7	0			75.4
	Finals Including Playoff		2	19	5	1206	1466	82.3
1985	Prelims		1	7	0	301	3580	86.0
	Championship Finals		2	28	3	1504	1862	80.8
1987	Prelims		1	7	0	293	350	83.7
	Championship Finals		6	22	9	1602	2062	77.7

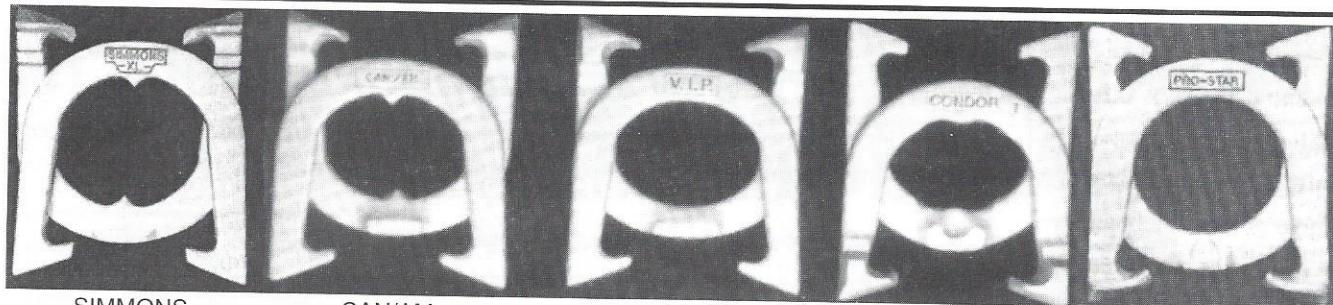

SIMMONS

CAN/AM

VIP

CONDOR

PRO/STAR

BILL VANDERBURG
HORSESHOE COMPANY
201-30 Avalon Place
Kitchener, ON N2M 4N6

(519)575-9163



Thrown by the 2002 World Champion

SIMMONS - XL: Thrown by the 2000 World Champion, Brian Simmons at 85%. M - H. Price \$50.00

CONDOR: Perfectly balanced flip. Thumb Indentation. Can be thrown with lugs up or down. L-M-H.

PRO-STAR: Designed to flip, can be thrown up or down. New Thumb Indentation. Weight L-M-H.

VIP: Designed for flip & the 3/4 turn. Has a good heavy lug. Weight L-M-H.

CAN-AM: A super shoe for the 3/4 turn, 1/4 and 1/4 turn. L-M-H.

PRICE: \$43.00—Shipping & Taxes extra. 1 year guarantee. Order through your NHPA Representative

U.P. SPORTS HALL OF FAME

The following article was published on August 29, 2002 by The Wakefield News and is being copied with their permission.

Wakefield horseshoe pitcher elected to U.P. Sports Hall of Fame

IRON MOUNTAIN — Ray Hill, Wakefield's world senior horseshoe pitching champion extraordinaire, has added another fitting accolade to his great achievements—being named to the Upper Peninsula Sports Hall of Fame.

The Sports Hall committee named Hill at its annual selection meeting held in Iron Mountain in July.

Already a two-time world senior champion, he also finished as runner-up three times, and was named to the horseshoe pitchers halls of fame for the states of Michigan and Wisconsin (honorary) simultaneously.

The U.P. Hall of Fame really gets close to honoring Hill on his home turf, although Hill seems to be right at home anywhere and everywhere competition takes him.

Hill has competed as a charter level in the Gogebic County Range League and consistently performed at championship level. He reigned as U.P. champ in 1973 and 1974, and



Already a member of the Michigan horseshoe hall of fame and an honorary member of the Wisconsin hall, Wakefield horseshoe pitcher Ray Hill now has been elected to the U.P. Sports Hall of Fame as the first representative of his sport. The former world senior champion will be inducted in April. Hill displays his flawless form at his home court, in Pike Location. Photo by Hank Backman - Wakefield News

sudden death playoff. He had a masterful 78 percent ringer percentage. In that title match he kept his overall ringer percentage to 76.1.

Hill will be honored at the annual U.P. Sports Hall of Fame banquet next spring in Iron Mountain.

Special congratulations, Ray, for your fine achievement in the horseshoe pitching arena during your years of successful competition.

continued to conquer all comers in meets at Mountain, Wis., Duluth, Minn., and Marshfield, Wis., held during the summer of his greatest achievements in world championship play.

When he rose up, accomplishing his greatest feats at that point, Hill pitched a record 76.6 percent ringers, defeating horseshoe legend Glen "Red" Henton, an Iowan, who placed second with 69.3 percent ringers.

Another conquest that week was topping defending world champion, Willard "Spud" Napier, of California.

In his title match Hill captured 18 matches without defeat in three days of competition at the National Horseshoe Pitching Tourney at Eau Claire, Wis.

In 1989, Hill won his second world title defeating Henton 40-38, in a

MARYLAND STATE CHAMPIONSHIPS CORRECTION

In the January/February 2003 issue, the "Horseshoe Pitching Newsline" mistakenly reported the 2nd Place finishers as the winners for all classes in Maryland's State Championships. My apologies to the actual winners (listed here) for the error.

Paula Summerlin, Editor

Class	W/L	%						
Men's A			Men's F			Junior Girls		
Elbert Shifflet	1/0	74.64	Rocky Mabry	6/0	21.67	Kimberly Mabry	2/1	6.50
Men's B			Men's G			Junior Boy's A		
Charles Bullock	5/1	51.44	Paul McGee	4/1	30.45	Steven Proctor	0/0	24.39
Men's C			Ladies A			Junior Boy's B		
Charles Wainwright	7/0	45.79	Melissa Lovejoy	3/1	51.74	Zachary Short	0/0	8.13
Men's D			Ladies B					
Bob Helmick	5/1	37.06	JoAnn Beard	2/0	36.13			
Men's E			Elder Men's					
Don Lawyer	9/2	29.55	Stacy Wiitala	3/0	27.44			

ANNUAL 45TH VALLEY OF THE SUN

Tournament Results *Submitted by Rick Durkit*

The Phoenix-Mesa Horseshoe Pitchers Club held their annual 45th Valley of the Sun Horseshoe Tournament, the oldest running NHPA sanction tournament in the U.S. Players entered from 27 States and four Provinces of Canada. This year was the largest payout we have ever had. Imagine this if you will! On opening day we had a rain delay of one hour and then on top of that we got rained out two days. This is a rarity here in the Arizona Desert where it very seldom rains. It was very disappointing to those

who did not get to play. The PMHPC hopes this will not discourage the horseshoe players from coming back for next year's tournament February 8th through the 16th 2004.

Classes D 30', D 40', C 40' and B 40' were rained out. Pitchers that finished in the top half of the other groups are listed below.

Class A 30'

1. Roland Kleinschmidt	S. Dakota	11/1	70.0%
2. Judy Curtiss	Michigan	10/2	73.4%
3. Don Wild	Colorado	8/4	61.1%
4. Jan Turnquist	Minnesota	6/6	60.0%

Class A 40'

1. Paul LaCrosse	Colorado	13/1	73.6%
2. Bob Hayes	New York	10/4	68.7%
3. Tom Westbrook	S. Carolina	9/5	59.9%
4. Rich Pintor	Colorado	7/7	62.1%

Class B 30'

1. Marion Thomsen	Nebraska	10/1	59.0%
2. Ken Wollery	California	9/2	54.7%
3. Tony Paiz	Colorado	9/2	54.0%
4. Jane Jordan	S. Carolina	7/4	60.0%
5. Oattie Reno	Ohio	6/5	52.9%
6. Bob Long	Missouri	6/5	52.5%

Class C 30'

1. Carol Hoppe	Arizona	5/1	50.8%
2. Alyeene Hensley	Oklahoma	5/1	45.4%
3. Ida Boschman	B. Columbia	5/1	42.9%
4. Don Livingston	Arizona	4/2	50.0%
5. Cheri Smith	Arizona	4/2	39.5%
6. Patty Ingraham	Michigan	3/3	46.2%

Class E 30'

1. Janice Knaub	Colorado	9/2	40.0%
2. John Hargrove	Missouri	8/3	30.6%
3. Wayne Jensen	Colorado	7/4	36.1%
4. Kent Robinson	S. Dakota	6/5	35.9%
5. Howard Ackeborg	Arizona	6/5	33.8%
6. Ted Clark	Iowa	6/5	33.6%

Class E 40'

1. Max Curtiss	Michigan	9/2	27.5%
2. Don Sutton	Illinois	8.5/2.5	28.4%
3. Maurice Stern	B. Columbia	7/4	30.0%
4. Ray Hawkins	Oregon	6.5/4.5	30.9%
5. Richard Stormont	Arizona	6/5	28.4%
6. Howard Reed	Kansas	6/5	27.9%

Class F Mixed

1. Al Baez	Arizona	10.5/1.5	20.4%
2. Al Ayers	Arizona	7.5/3.5	35.2%
3. Berditte Finton	S. Dakota	7/4	25.0%
4. Harold Barker	Iowa	6.5/4.5	22.7%
5. Louise Christianson	Alberta	6/5	20.2%
6. Earl Cummings	Wisconsin	6/5	20.2%

Class G Mixed

1. Art Anderson	California	9/2	22.9%
2. John Garcia	California	2/2	22.7%
3. Darrell Buell	Arizona	8/3	22.9%
4. Red Homuth	Arizona	8/3	11.5%
5. Jennifer Johnson	Colorado	6.5/4.5	7.0%
6. Doyle Adamson	Colorado	6/5	19.5%

THE TOLL OF TIME

Robert (Bob) Pence

Indiana

12/7/1909 - 5/18/2002

Bob Pence passed away May 18th at the Cardinal Nursing Home in South Bend, Indiana. His wife Lois passed away July 3, 2000. He is survived by a son, Jerry of North Liberty, IN, two daughters, Janet Kent of Lynchfield, ME and Judy Pence of Albuquerque, NM and two grandchildren.

Bob was a veteran of the US Army Air Corps. He retired after 35 years from The USS Steel, Gary, Indiana

Bob joined the NHPA in 1929. He served as NHPA Sec./Treas. from 1958 to 1972 and was tournament director for 15 world tournaments. Bob also served as Indiana Sec./Treas. and Indiana President. He was responsible for establishing the NHPA Hall of Fame. Bob received the NHPA Stokes Award in 1961. The NHPA gives a Bob Pence membership award every year at the Awards Banquet to the charter with the most adult members. Bob dedicated a great number of years to horseshoes.

The NHPA and Indiana Association send our sympathy to his family.

Orville Baker

Wisconsin

Orville Baker, age 73 of Platteville, Wisconsin, died on November 23, 2002 from complications after surgery on a stomach aneurism.

Orville loved playing horseshoes and had pitched in the Platteville leagues (mostly twice a week) for the past twenty-one years. It was during that time that he became an NHPA member. He was a farmer for twenty-two years, and after losing a leg in an accident he then started a welding and machining shop. Orville and his son Jeff did all the welding and fabrication for the Platteville courts. Orville constructed two portable clay courts on wheels and invited his friends to play twice a week at his welding shop during the winter months. There were a lot of great games played for many years. Orville was well liked and his distinctive laugh and outstanding sense of humor made everyone's pitching experience more enjoyable. He will be greatly missed by the Platteville Horseshoe Association and all others who knew him.

He is survived by his wife of 53 years, Betty; two sons, Gary and Jeff; three daughters, Judy Soles, Jan Brame, and Kim Lipska; two brothers, Lee and Larry; one sister, Donna Stephens; and 16 grandchildren.

TOURNAMENT TRAVEL CONTACTS

The following is a list of all NHPA Regional Directors and the states or territory they cover. Those of you who travel and want to get out-of-area tournament information, are encouraged to contact the appropriate Regional Director. Each RD maintains a full list of all NHPA sanctioned tournaments in their area. If your travel plans call for stops in several states and you need multiple site information, you might want to write the NHPA 1st Vice-President who is in charge of all RDs. He should have copies of all the state schedules. The address for the 1st VP can be found on page 3 of this publication.

REGION	REGIONAL DIRECTOR				
26. Alabama	Ron Kindrick 678 Williamson Kindrick Trail Eclectic, AL 36024 (334) 541-2720 ron@cmielelectronics.com	31. Indiana	Jim Shilling 5044A CR 64 Spencerville, IN 46788 (260) 238-4879	40. North Carolina	Wayne Roope 358 Roop Road Hays, NC 28635 (336) 957-8396
52. Alaska	Pete Imhof 9031 Tern Drive Palmer, AK 99645 (907) 746-2030	24. Iowa	C. Leo Buell 1809 Lakeside Drive Iowa City, IA 52240 (319) 338-8256 clbic52@willinet.net	15. North Dakota	Clint Bryson 901 Custer Street Belle Fourche, SD 57717 (605) 892-2195
10. Arizona	Ernie Swann 1875 E. Junction Apache Junction, AZ 85219 (480) 982-8001 L.A.Swann@worldnet.att.net	18. Kansas	Bernie VanLerberg 12419 142 nd Street Bonner Springs, KS 66012 (913) 422-7095	36. Ohio	Dan Sanders 6687 Merwin Road Columbus, OH 43235 (614) 761-3357
21. Arkansas	Richard Archer 3006 Barnes Road Ozark, AR 72949 (479) 667-3078 aturnsho@ipa.net	32. Kentucky	Monty Roberts Box 637 Warsaw, KY 41095 (606) 567-8511	20. Oklahoma	Ronnie Frederick 1015 19 th Street Woodward, OK 73801 (580) 256-2759
3. California (Northern)	Gail Sluys 1721 San Ramon Way Santa Rosa, CA 95409 (707) 538-3128 kcslus@worldnet.att.net	27. Louisiana	Ron Latiolais 12102 Turry Road Gonzales, LA 70737 (225) 647-4992	2. Oregon	See Idaho
4. California (Southern)	Fred Briand P.O. Box 1137 North Edwards, CA 93523 (760) 769-4347	45. Maine	See Connecticut	39. Pennsylvania	Darle Esh 68 Solitude Road Milroy, PA 17063 (717) 667-3108
61-72. Canada	Jack Adams 35 O'Neil Crescent Saskatoon, SK Canada S7N 1W7 (306) 373-5184	42. Maryland	See Delaware	50. Rhode Island	See Connecticut
13. Colorado	Don Conklin 898 Sycamore Avenue Boulder, CO 80303 (303) 499-9091	48. Massachusetts	See Connecticut	41. South Carolina	Ron Taylor 1915 Molly Circle York, SC 29745 (803) 684-1453
49. Connecticut	George St. Pierre 25 Leefort Terrace Salem, MA 01970 (978) 744-3110	30. Michigan	Steve Summerlin P.O. Box 536 Webberville, MI 48892 (517) 521-1262 ssummerlin@cablespeed.com	16. South Dakota	See North Dakota
43. Delaware	Don Lawyer 730 Hickok Trail Lusby, MD 20657 (410) 326-2070	23. Minnesota	Ward Lutz 900 11-1/4 Street SW Rochester, MN 55902 (507) 288-5182	33. Tennessee	Dexter Stallings 731 Reed Drive Powell, TN 37849 (865) 947-7865
35. Florida	Ron Deckard 7302 Brookview Circle Tampa, FL 33634 (813) 884-2932	25. Mississippi	See Alabama	22. Texas	Randy Collins 3902 Ravenwood Bryan, TX 77802 (979) 776-1148
34. Georgia	Jerome Kennedy Rt. 2, Box 1315 Hawkinsville, GA 31036 (478) 892-3885	19. Missouri	Elwyn Cooper 6920 N.W. 78 th Street Kansas City, MO 64152 (816) 741-0043	9. Utah	Bud Schardine 354 Brookside Drive Springville, UT 84663 (801) 489-6351
6. Hawaii	Myrtle May L. Kamoku P. O. Box 273 Anahola, Hawaii 96703 (808) 821-0602	11. Montana	Wayne Bennett 1520 Beartooth Road Wolf Creek, MT 59648 (406) 235-4062	46. Vermont	See Connecticut
8. Idaho	Rick Rebman 80037 Ross Lane Hermiston, OR 97838 (541) 567-8560	17. Nebraska	Pat Wemhoff 255 6 th Avenue, South Columbus, NE 68601 (402) 564-7323	38. Virginia	Kevin Snelgrove P.O. Box 625 Stuarts Draft, VA 24477 (540) 337-4689 king@vaix.net
29. Illinois	Dave Shreve 2127 Lynn Street Cahokia, IL 62206 (618) 332-2599	7. Nevada	Don Weaver 2206 Sunnyslope Avenue Las Vegas, NV 89119 (702) 736-7348	1. Washington	Vey Allen 1105 Ione Drive Benton City, WA 99320-4523 (509) 588-3351 veyallen@3-cities.com
		47. New Hampshire	See Connecticut	37. West Virginia	Ken Wilhelm 405 Stealy Avenue Clarksburg, WV 26301 (304) 622-1265
		51. New Jersey	Ed Quigley 27 Mountain Avenue Pompton Plains, NJ 07444 (973) 839-0946	28. Wisconsin	Jim Haupt 5075 N. Elkhart Avenue Milwaukee, WI 53217 (414) 964-2735
		14. New Mexico	David Romero P.O. Box 10329 Albuquerque, NM 87184 (505) 899-7140 dsrom@aol.com	12. Wyoming	Pat Bacus 440 W. 3 rd Lovell, WY 82431 (307) 548-6593
		44. New York	Jack Stenberg 1880 E. River Rd. Waterloo, NY 13165 (315) 539-8542 jstenberg@flare.net		



NHPA GAME RELATED SALES DISTRIBUTORS

EDWARD A. DOMEY

National Buyer
P.O. Box 298
Sutton, Massachusetts 01590
(508) 865-9477 Phone or Fax

DENNIS OHMS

777 W. Midvalley Road
Cedar City, Utah 84720
(435) 586-9352
ohms@netutah.com

HERB HEESCH

12591 South East 137 Court
Dunnellon, FL 34431
(352) 489-5954
hhwheesch@aol.com

KEN KOSKY

Assistant National Buyer
6007 Municipal Street
Schofield, WI 54476
(800) 535-0172

WALLY SHIPLEY

2646 Basswood Street
Newport Beach, CA 92660
(949) 760-3658

JIM & CAM SHILLING

5044 A County Rd. 64
Spencerville, IN 46788
(260) 238-4879

LUCKY SHOES PRO SHOP

83441 CR 652
Lawton, MI 49065
(616) 624-2861
luckshoe@juno.com

Support Your National Horseshoe Pitchers Association

Contact a Distributor near you for the products shown in this ad and many other Game Related Items

St. Pierre AMERICAN Tournament... HORSESHOES

THROW RINGERS AROUND THE COMPETITION.

UNIQUE SHAPE FOR CONSISTENT PERFORMANCE

- Longer hooks grab the stake
- Ringer breaker rotates shoe to lock in ringers
- Calks engineered for balance
- Built-in finger positioner
- Exclusive new high-tech powder coat finish
- Manufactured of forged steel

Our shoes are drop forged of solid steel and then given our exclusive smooth, electrostatically applied baked-on powder coating, a finish that's more resistant to chipping, abrasion, corrosion and weathering than ordinary paint. Only St. Pierre offers this durable, attractive finish. Our forged shoes also offer the proper weight distribution for maximum balance and control, and meet the official size and weight requirements of the National Horseshoe Pitchers' Association (NHPA). We forge strength right into the design, too, so St. Pierre shoes last longer than cast products.



NHPA
APPROVED

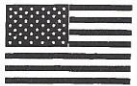

Made in USA



St. Pierre
MANUFACTURING CORPORATION

317 East Mountain Street
Worcester, MA 01606

Tel: (508) 853-8010 Fax: (508) 853-3860



NHPA NEWSLINE

VOL. 15, ISSUE 2

Subscription Office

3085 76th St., Franksville, WI 53126

CHANGE SERVICE REQUESTED

PRESORTED
STANDARD
US POSTAGE PAID
LANSING, MI
PERMIT NO 933